



**Invitation
For
Bids
(Federal)**

**DULLES
WAREHOUSE
SHELVING**

**RAILYARD
AND RACK**

IFB No.: FQ19023/GG

Date: August 22, 2018

Table of Contents

NOTICE TO BIDDERS.....	1
NOTICE TO ALL VENDORS.....	2
SOLICITATION, OFFER AND AWARD	3
PRICE SCHEDULE CONTINUATION SHEET	4
IFB SOLICITATION INSTRUCTIONS.....	7
1. INTRODUCTION.....	7
2. GOODS TO BE FURNISHED/SERVICES TO BE SUPPLIED	7
3. COMMUNICATIONS WITH THE AUTHORITY	7
4. PREPARATION OF BIDS.....	8
5. EXPLANATIONS TO BIDDERS	8
6. PRE-BID CONFERENCE.....	9
7. AMENDMENTS PRIOR TO DATE SET FOR OPENING OF BIDS	9
8. ACKNOWLEDGMENT OF AMENDMENTS	9
9. PREPARATION OF BIDS.....	10
10. SUBMITTAL OF BIDS.....	10
11. RESPONSIVE BIDS.....	10
12. LATE BIDS AND MODIFICATIONS OR WITHDRAWALS PRIOR TO BID OPENING	11
13. BID ACCEPTANCE PERIOD AND BIDDER'S DEFAULT	11
14. BID GUARANTEE.....	12
15. BID MISTAKE	12
16. REPRESENTATIONS, CERTIFICATIONS, AND ACKNOWLEDGMENTS.....	12
17. LAWS AND REGULATIONS	13
18. ROYALTY INFORMATION.....	13
19. REQUIREMENT FOR COST DATA FOR CONTRACT AWARD	13
20. PRE-AWARD INFORMATION/BIDDER RESPONSIBILITY	13
21. PRE-AWARD RESPONSIBILITY MEETING.....	14
22. SITE VISIT/INSPECTION OFFEROR'S FACILITIES.....	14
23. BASIS FOR CONTRACT AWARD.....	14
24. EQUAL EMPLOYMENT OPPORTUNITY	15
25. PERFORMANCE/PAYMENT BONDS.....	15
26. DISADVANTAGED BUSINESS ENTERPRISES REQUIREMENTS	15
27. OPPORTUNITY FOR DISADVANTAGED BUSINESS ENTERPRISES TO BID.....	16
28. NOTICE OF PROTEST POLICY.....	16
29. WMATA'S TAX EXEMPT STATUS	16
30. ENGLISH LANGUAGE AND UNITED STATES CURRENCY	16
31. BRAND NAME OR EQUAL.....	17
32. REQUESTS FOR RECORDS.....	17
REPRESENTATIONS & CERTIFICATIONS.....	20
1. TYPE OF BUSINESS ORGANIZATION.....	20
2. AFFILIATION AND IDENTIFYING DATA.....	20
3. PREVIOUS CONTRACTS AND COMPLIANCE REPORTS	21
4. DISADVANTAGED BUSINESS ENTERPRISE	21
5. SMALL BUSINESS ENTERPRISE (MAY 2015).....	22

6.	AFFIRMATIVE ACTION COMPLIANCE	22
7.	COVENANT AGAINST GRATUITIES	22
8.	CONTINGENT FEES	23
9.	CLEAN AIR ACT AND CLEAN WATER ACT CERTIFICATION.....	23
10.	DEBARMENT, SUSPENSION, INELIGIBILITY, AND VOLUNTARY EXCLUSION.....	24
11.	CERTIFICATION OF INDEPENDENT PRICE DETERMINATION	25
12.	CERTIFICATION OF NONSEGREGATED FACILITIES	25
13.	NONDISCRIMINATION ASSURANCE.....	26
14.	CERTIFICATION OF RESTRICTIONS ON LOBBYING.....	27
15.	BUY AMERICA ACT CERTIFICATION.....	28
16.	CERTIFICATION OF NON-DELINQUENT TAXES	28
17.	DISCLOSURES OF INTERESTS OF WMATA BOARD MEMBERS.....	29
18.	CRIMINAL BACKGROUND SCREENING CERTIFICATION (QUARTERLY).....	30
19.	CERTIFICATION REQUIRED FOR ALL SAFETY-SENSITIVE CONTRACTS.....	31
	PRE-AWARD EVALUATION DATA	33
	TERMS AND CONDITIONS.....	35
	CHAPTER I – TERMS AND CONDITIONS.....	36
1.	AGREEMENT.....	36
2.	ARRANGEMENT OF CONTRACTUAL PROVISIONS	36
3.	ORDER OF PRECEDENCE	36
4.	REQUIREMENTS CONTRACT Not Applicable.....	36
5.	INDEFINITE QUANTITY CONTRACT Not Applicable	36
6.	ORDERING.....	36
7.	ORDER LIMITATIONS	36
8.	AUDIT, AVAILABILITY, AND INSPECTION OF RECORDS- FTA.....	36
9.	AVAILABILITY OF FUNDS FOR THE NEXT FISCAL YEAR	37
10.	CONTRACTING OFFICER’S TECHNICAL REPRESENTATIVE (COTR).....	37
	CHAPTER II – TIME/DELAYS/LIQUIDATED DAMAGES.....	40
1.	PERIOD OF PERFORMANCE.....	40
2.	OPTIONS- EVALUATION.....	40
3.	OPTIONS- EXERCISE.....	40
4.	OPTION FOR INCREASED OR DECREASED QUANTITIES OF SUPPLIES	41
5.	OPTIONS TO EXTEND SERVICES	42
6.	OPTION TO EXTEND THE TERM OF THE CONTRACT	42
7.	OPTIONS EXERCISED OUT OF SEQUENCE	42
8.	LIQUIDATED DAMAGES FOR DELAY	42
9.	EXTENSIONS OF TIME/FORCE MAJEURE	42
10.	THE AUTHORITY’S DELAY	43
11.	NOTICE TO THE AUTHORITY OF LABOR DISPUTES.....	44
12.	NOTIFICATION OF BANKRUPTCY OR INSOLVENCY	44
	CHAPTER III – ACCEPTANCE/INSPECTIONS/DEFICIENCIES	46
1.	INSPECTION OF SERVICES.....	46
2.	INSPECTION OF SUPPLIES	46
3.	ACCEPTANCE OF SUPPLIES.....	47
4.	NEW MATERIAL [SUPPLIES].....	48
5.	WARRANTY OF SUPPLIES	48

6.	WARRANTY OF SERVICES	49
7.	CORRECTION OF DEFICIENCIES.....	49
8.	FIRST ARTICLE INSPECTION.....	50
9.	F.O.B. DESTINATION	50
10.	QUALITY ASSURANCE/QUALITY CONTROL.....	50
CHAPTER IV—CHANGES/ PRICING ADJUSTMENTS.....		52
1.	CHANGE ORDERS.....	52
2.	PRICING OF ADJUSTMENTS.....	53
3.	ACCOUNTING AND RECORD KEEPING FOR ADJUSTMENTS	53
CHAPTER V – INVOICES/PAYMENTS/ DEDUCTIONS		55
1.	BILLING AND PAYMENT.....	55
2.	PRICE REDUCTION FOR DEFECTIVE COST OR PRICING DATA – MODIFICATIONS	55
3.	SUBCONTRACTOR PAYMENTS.....	56
4.	GARNISHMENT OF PAYMENTS.....	56
CHAPTER VI – CONTRACT TERMINATION/STOP WORK ORDERS/DISPUTES.....		57
1.	STOP WORK ORDERS	57
2.	TERMINATION FOR DEFAULT- FTA.....	57
3.	TERMINATION FOR CONVENIENCE- FTA	59
4.	ASSIGNMENT- FTA	62
5.	DISPUTES- FTA.....	63
6.	EQUAL EMPLOYMENT OPPORTUNITY REQUIREMENTS FOR CONSTRUCTION ACTIVITIES.....	63
CHAPTER VII – INDEMNIFICATION/INSURANCE/RISK OF LOSS.....		64
1.	INDEMNIFICATION	64
2.	INSURANCE REQUIREMENTS	64
3.	TITLE AND RISK OF LOSS	67
4.	TRANSIT EMPLOYEE PROTECTIVE ARRANGEMENTS – FTA.....	68
5.	VETERANS PREFERENCE- FTA.....	68
6.	INAPPLICABILITY OF CLAUSES REQUIRING UNAUTHORIZED OBLIGATIONS.....	68
CHAPTER VIII – INTELLECTUAL PROPERTY RIGHTS		70
1.	PATENT INDEMNITY	70
2.	SET-OFF.....	70
3.	Not Applicable	70
4.	RIGHTS IN TECHNICAL DATA – UNLIMITED	70
5.	NOTICE AND ASSISTANCE REGARDING PATENT AND COPYRIGHT INFRINGEMENT [SUPPLIES]	72
CHAPTER IX – ADDITIONAL COVENANTS/LEGAL REQUIREMENTS		74
1.	NONDISCRIMINATION ASSURANCE- FTA	74
2.	CONTRACT WORK HOURS AND SAFETY STANDARDS ACT-OVERTIME COMPENSATION.....	75
3.	WALSH-HEALEY PUBLIC CONTRACTS ACT.....	76
4.	DAVIS-BACON ACT- FTA	76
5.	COPELAND ANTI-KICKBACK ACT – FTA	76
6.	CONVICT LABOR.....	76

7.	COVENANT AGAINST CONTINGENT FEES.....	77
8.	SEAT BELT USE POLICY.....	77
9.	SENSITIVE SECURITY INFORMATION.....	77
10.	LAWS AND REGULATIONS.....	78
11.	HAZARDOUS MATERIAL IDENTIFICATION AND MATERIAL SAFETY DATA.....	78
12.	LIVING WAGE.....	79
13.	METRIC SYSTEM.....	80
14.	MANDATORY DISCLOSURE.....	80
15.	WHISTLEBLOWER PROTECTION – FEDERAL.....	81
16.	WORKPLACE VIOLENCE/ZERO TOLERANCE.....	83
17.	DRUG AND ALCOHOL TESTING (FOR SAFETY SENSITIVE FUNCTIONS ONLY) – FTA.....	83
18.	EMPLOYMENT RESTRICTION WARRANTY.....	84
19.	GRATUITIES.....	85
20.	OFFICIALS NOT TO BENEFIT.....	85
21.	ORGANIZATIONAL CONFLICTS OF INTEREST.....	86
22.	CONTRACTOR PERSONNEL.....	87
23.	FALSE STATEMENTS, CLAIMS OR SUBMISSIONS.....	87
CHAPTER X – MISCELLANEOUS ADDITIONAL PROVISIONS.....		89
1.	FEDERAL, STATE, AND LOCAL TAXES.....	89
2.	PUBLIC COMMUNICATION.....	89
3.	CHOICE OF LAW, CONSENT TO JURISDICTION AND VENUE.....	90
4.	SEVERABILITY.....	90
5.	SURVIVAL.....	90
CHAPTER XI – ADDITIONAL FEDERAL PROVISIONS.....		91
1.	NOTIFICATION OF FEDERAL PARTICIPATION- FTA.....	91
2.	ALL NECESSARY FEDERAL PROVISIONS DEEMED INCLUDED- FTA.....	91
3.	ACCESS TO THIRD PARTY CONTRACT RECORDS- FTA.....	91
4.	AMERICANS WITH DISABILITIES ACT ACCESSIBILITY – FTA.....	91
5.	RIGHTS IN DATA AND COPYRIGHTS — FTA.....	92
6.	PATENT RIGHTS- FTA.....	93
7.	BUY AMERICA ACT- FTA.....	93
8.	PRE-AWARD AND POST DELIVERY AUDIT REQUIREMENTS – FTA.....	94
9.	CHARTER BUS REQUIREMENTS- FTA.....	94
10.	SCHOOL BUS REQUIREMENTS- FTA.....	94
11.	BUS TESTING- FTA.....	95
12.	CARGO PREFERENCE- FTA.....	95
13.	CLEAN AIR ACT- FTA.....	95
14.	CLEAN WATER ACT- FTA.....	96
15.	RECOVERED MATERIALS/ RECYCLED PRODUCTS- FTA.....	96
16.	RETAINAGE.....	96
17.	ENERGY CONSERVATION- FTA.....	96
18.	CHANGES TO FEDERAL REQUIREMENTS- FTA.....	97
19.	FLY AMERICA REQUIREMENTS- FTA.....	97
20.	PAYMENT DEDUCTIONS - NONCOMPLIANCE WITH DBE REQUIREMENTS- FTA.....	97
21.	GOVERNMENT-WIDE DEBARMENT OR SUSPENSION- FTA.....	98
22.	INCORPORATION OF FEDERAL TRANSIT ADMINISTRATION (FTA) TERMS.....	98

23.	NO FEDERAL GOVERNMENT OBLIGATIONS TO THIRD PARTIES- FTA	99
24.	FALSE STATEMENTS OR CLAIMS CIVIL AND CRIMINAL FRAUD- FTA	99
25.	LOBBYING- FTA	99
26.	NATIONAL INTELLIGENT TRANSPORTATION SYSTEMS ARCHITECTURE AND STANDARDS-FTA	100
27.	CONTRACTS INVOLVING FEDERAL PRIVACY ACT REQUIREMENTS- FTA	100
28.	PROGRESS PAYMENTS	100
29.	BONDING FOR CONSTRUCTION PROJECTS EXCEEDING \$150,000 – FTA	101
30.	BONDING REQUIREMENTS- GENERAL	102
31.	SEISMIC SAFETY – FTA	103
	CHAPTER XII-WMATA POLICIES	104
1.	SAFETY REQUIREMENTS	104
2.	PRE-EMPLOYMENT CRIMINAL BACKGROUND CHECK REQUIREMENT	105
3.	WORKPLACE VIOLENCE/ZERO TOLERANCE	106
	MID-ATLANTIC COOPERATIVE RIDER CLAUSE	107
	BOND FORMS	108
	TECHNICAL SPECIFICATIONS- SCOPE OF WORK	109
	APPENDIX B	115
	APPENDIX B-1	141
	SMALL BUSINESS ENTERPRISE PROGRAM (SBE)	143
	ATTACHMENT A – DRAWINGS	157
	ATTACHMENT B - WAREHOUSE AND RACK SHELVING REQUIREMENTS MANUAL	158
	ATTACHMENT C – SAFETY, SECURITY, ACCESS	159
	ATTACHMENT D - MAP VIEW OF THE SITE VISIT LOCATION	160
	COMBINED GLOSSARY OF DEFINITIONS	161

Washington Metropolitan Area Transit Authority
IFB: FQ19023/GG

Date:

SUBJECT: IFB No. FQ19023

Dear Sir/Madam:

The Washington Metropolitan Area Transit Authority (WMATA) is seeking bids from qualified contractor to provide warehouse and rack shelving units that include pallet racks, bulk racks, bar pipe and rod racks, and cantilever racks for the material handling storage in the new Dulles Railyard and Maintenance Facilities being constructed on Old Ox Road in Sterling, VA 20166. Small Business Enterprise Program (SBE) and Disadvantaged Business Enterprises (DBE) Program do not apply to this Solicitation. However, eligible DBE or SBE firms are welcome to submit the Bids.

A pre-bid conference will/ be held. Your company's bid must be submitted in accordance with the IFB's terms and delivered to WMATA's, Office of Procurement and Materials, 600 Fifth Street, NW, Room 3C-02, Washington, DC 20001-2651, no later than 2:00 p.m. on September 19, 2018 _____.

If you have any technical, contractual, or administrative questions, please e-mail them to ggufranova@wmata.com no later than close of business, September 10, 2018. WMATA will provide written answers by e-mail to all those who obtain the IFB and provide their e-mail addresses.

The following documents must be completed, signed and submitted with your company's bid:

Price Schedule;

Solicitation, Offer & Award form (including Continuation Sheet on p.5) ;

Representations and Certifications;

Sincerely,



Contracting Officer
Office of Procurement and Materials

Washington Metropolitan Area Transit Authority
IFB: FQ19023/GG

INTRODUCTORY INFORMATION
SOLICITATION CERTIFICATIONS PAGE

FQ19023/GG

DULLES RAILYARD WAREHOUSE AND RACK SHELVING

APPROVED FOR RELEASE

FOR GINNA GREENBAUM
Project Manager/Office Designee

AUGUST 17, 2018
Date



Contracting Officer

8-22-2018
Date

END OF SECTION

Washington Metropolitan Area Transit Authority
IFB: FQ19023/GG

**NOTICE TO BIDDERS
IMPORTANT
PLEASE READ CAREFULLY**

To ensure submission of complete bids and to avoid irregularities that could result in a non-responsive bid, please check your company's bid for each of the following common responsiveness problems:

1. Have you checked your company's bid? Are all items included and checked for math errors?
2. If amendments are included, has your company acknowledged and recorded the number of amendments on the bid envelope and bid form?
3. Has your company signed and submitted the Solicitation, Offer & Award page(s)?
4. Has your company properly completed and checked the appropriate box for each Certification and Representation? Have you included the Representations and Certifications with your company's bid?
- 5.
6. Has your company complied with the Appendix B or B-1 requirement (if applicable)?
7. Has your company marked the bid envelope with solicitation number and addressed it to the Contract Administrator (Guzel Gufranova)?

Note: Contractor's pricing, if offered to other jurisdictions, will be the same regardless of quantities ordered. The Authority makes no representations regarding the quantities that may be ordered by any other jurisdictions.

NOTICE TO ALL VENDORS

Please be advised that all vendors and contractors who do business with the Washington Metropolitan Area Transit Authority (WMATA) must register in the WMATA Vendor Registration System. Registration is located at <http://www.wmata.com>
New Vendor Registration.

If you are a vendor or contractor and *HAVE* done business with WMATA in the past, please electronically request your company's User ID and Password at <http://www.wmata.com>
Forgot User Id/Password.

Registered Vendor Benefits:

- Visibility to WMATA contract administrators and/or purchasing agents during the purchasing decision period;
- Visibility to other 17,500 registered vendors for possible business opportunities;
- Opportunity to update online, company information such as an e-mail address or contact person on-line;
- Ability to sign up for electronic payment option; and
- Ability to electronically reset user id and password.

Any questions regarding registration may be sent to clm@wmata.com.

WASHINGTON METROPOLITAN AREA TRANSIT AUTHORITY
 SUPPLY AND SERVICE CONTRACT IFB FQ19023/GG



WASHINGTON METROPOLITAN AREA TRANSIT AUTHORITY
SOLICITATION, OFFER AND AWARD

CONTRACT NO.	SOLICITATION NO. IFB FQ19023/GG	DATE ISSUED	ADDRESS OFFER TO OFFICE OF PROCUREMENT Office of Procurement 600 Fifth Street NW Washington, DC 20001
<input checked="" type="checkbox"/> ADVERTISED <input type="checkbox"/> NEGOTIATED			

SOLICITATION

Sealed offer in original and TWO (2) copies for furnishing the supplies or services in the schedules will be received at Authority until 2:00 P.M. Local time September 19, 2018
 (Hour) (Date)

If this is an advertised solicitation, offers will be publicly opened at that time.

CAUTION – LATE OFFERS: See paragraph 6 of Solicitation Instructions.

All offers are subject to the following:

1. The Solicitation Instructions that are attached.
2. The Terms and Conditions that are attached.
3. The Price Schedule included herein and/or attached hereto.
4. Such other provisions, representations, certifications, and specifications, as are attached or incorporated herein by reference.

Bidder's e-mail _____

Bidder's phone number _____

Bidder's fax number _____

PRICE SCHEDULE

ITEM NO.	SUPPLIES/SERVICES	QUANTITY	UNIT	UNIT PRICE	AMOUNT
	Refer to the next page				\$
(Continued on the attached pages)					

DUN & BRADSTREET ID NUMBER: _____

BIDDER

Name and Address (Street, city, county, state, and zip code)	Name and Title of Person Authorized to Sign Offer (Print or Type)
<input type="checkbox"/> Check if remittance is different from above — enter such address in Schedule	Signature Offer Date

AWARD (To be completed by The Authority)

ACCEPTANCE AND AWARD ARE HEREBY MADE FOR THE FOLLOWING ITEM(S):

ITEM NO.	QUANTITY	UNIT	UNIT PRICE

The total amount of this award is \$ _____

Name of Contracting Officer (Print of Type)

WASHINGTON METROPOLITAN TRANSIT AUTHORITY

AWARD DATE

PRICE SCHEDULE CONTINUATION SHEET

IFB FQ19023/GG
 DULLES RAILYARD WAREHOUSE AND RACK SHELVING

TAG NO	FURNITURE TYPE	QTY	DIMENSIONS	MATERIALS & DELIVERY UNIT PRICE	INSTALL UNIT PRICE	TOTAL UNIT PRICE	TOTAL PRICE
A. MWB (MAINTENANCE OF WAY BUILDING)							
1420	RACK, ARM, SINGLE FACE, 7 ARM LEVELS, 7 FEET HIGH	3	36" L x 22" W x 79.25"H				
1456	RACK, BULK STORAGE, SOLID DECK	71	72" L x 24" W x 96"H				
1531	RACK, BULK STORAGE, SOLID DECK	38	108" L x 42" W x 144"H				
TOTAL		112					
B. SIB (SERVICE AND INSPECTION BUILDING)							
1533	RACK, PALLET, 42 INCHES DEEP, 16 FEET TALL, WIRE DECK	7	108" L x 42" W x 192"H				
1538	RACK, PALLET, 42 INCHES DEEP, 16 FEET TALL, WIRE DECK	4	60" L x 42" W x 192"H				
TOTAL		11					
C. WHB (WAREHOUSE BUILDING)							
1533A	RACK, PALLET, 48 INCHES DEEP, 16 FEET TALL, WIRE DECK	299	108" L x 48" W x 192"H				
1533C	RACK, CANTILEVER, HEAVY DUTY, SINGLE SIDED, 3 ARM LEVELS 12 FEET HIGH	29	72" L x 36" W x 144"H				
TOTAL							
TOTAL CONTRACT PRICE							

WASHINGTON METROPOLITAN AREA TRANSIT AUTHORITY

SOLICITATION, OFFER AND AWARD

CONTINUATION SHEET

THE UNDERSIGNED ACKNOWLEDGES RECEIPT OF THE FOLLOWING AMENDMENTS

TO SOLICITATION **IFB FQ19023/GG** _____

Amendment Number _____ Dated _____

Amendment Number _____ Dated _____

Amendment Number _____ Dated _____

Amendment Number _____ Dated _____

Amendment Number _____ Dated _____

Amendment Number _____ Dated _____

Failure to acknowledge receipt of all amendments may render the bid unacceptable.

Authorized Signature

Company Name

Date

SOLICITATION INSTRUCTIONS

IFB SOLICITATION INSTRUCTIONS

1. INTRODUCTION

- (a) The Authority seeks to award a contract to procure warehouse and rack shelving units in the new Dulles Railyard and Maintenance Facilities being constructed on Old Ox Road in Sterling, VA 20166 _____. To that end, WMATA is issuing this Invitation for Bids (IFB) to solicit bids from qualified firms and individuals who can satisfy the requirements of the Contract.
- (b) Since this is a low bid solicitation, award of a Contract hereunder shall be to the lowest priced, responsible bidder whose bid is responsive to, and meets all requirements of, the solicitation.
- (c) The Authority contemplates award of a firm fixed price Contract. Unless otherwise specified in the Price Schedule, the Authority reserves the right to make multiple awards pursuant to this solicitation.
- (d) **REQUIREMENTS CONTRACT** Not Applicable
- (e) In the event that the Contractor is unable or otherwise fails to provide goods or services within the time frames required in this Contract, the Authority reserves the right to procure them from any other source and in any other manner it deems appropriate. Nothing contained herein shall be deemed to waive, modify or impair the Authority's right to treat such failure as a material breach of the Contractor's obligations pursuant to the "Default" article of this Contract, or to pursue any other remedy to which the Authority may be entitled pursuant to this Contract, at law or in equity.
- (f) **INDEFINITE QUANTITY** Not Applicable

2. GOODS TO BE FURNISHED/SERVICES TO BE SUPPLIED

Bidders are advised that:

- (a) If "services" are to be performed pursuant to this solicitation, they must be provided in all respects as specified in the Contract and include the services to be furnished, together with any labor, materials or other work necessary for satisfactory and complete performance.
- (b) If "supplies" are to be provided pursuant to this solicitation, they must be delivered in all respects as specified in the Contract and include the items to be furnished, together with any labor, service or other work necessary for satisfactory and complete performance.
- (c) Contractor agrees that Project property will remain available to be used for its originally authorized purpose throughout its useful life or disposition.

3. COMMUNICATIONS WITH THE AUTHORITY

Prospective bidders are advised that any and all communications with WMATA relating to this solicitation and made by, or on behalf of, a prospective bidder at any time between release of this IFB and Contract award, must be directed to the Contract Administrator as follows:

Guzel Gufranova
WMATA/PRMT
600 Fifth Street N. W.
Washington D. C. 20001
ggufranova@wmata.com
(202) 962-5544

A violation of this provision, deemed willful by the Authority, may result in a determination that an offeror is not responsible, and thus ineligible for award, for purposes of this and/or future Authority solicitations.

4. PREPARATION OF BIDS

- (a) Bidders shall furnish all information requested by the solicitation and, in so doing, are expected to examine the IFB and all referenced documents carefully. Failure to do so will be at bidder's risk.
- (b) The bidder shall sign the solicitation and print or type its name on the Price Schedule and on each continuation sheet, if an entry has been made. Erasures or other changes must be initialed by the person signing the bid.
- (c) Bidders must state a definite time for delivery of supplies or for performance of services unless otherwise specified in the solicitation.
- (d) Bidders should be aware that all prices for the work shall be deemed to include the cost of all work, labor and materials required by the Contract including, without limitation, delivery charges, insurance, bond premiums or any other expenses required by this Contract, as well as expenses associated with compliance with Federal, State or local laws or regulatory requirements. All prices are deemed to be F.O.B. Destination.

5. EXPLANATIONS TO BIDDERS

- (a) Any explanation desired by a bidder regarding the meaning or interpretation of the solicitation or Contract including, without limitation, the terms and conditions, technical specifications or Scope of Work, and Contract drawings, must be requested in writing with sufficient time allowed for a reply to reach all bidders before the date that bids will be opened. Absent extraordinary circumstances, all inquiries must be transmitted in a time frame to ensure the Contracting Officer's receipt at least ten (10) days prior to the date specified for bid opening. All such requests must be submitted via e-mail or first class mail to the Contract Administrator identified in Paragraph 3. Include the IFB number and Contract title in any correspondence.
- (b) Any information that the Authority furnishes to a prospective bidder relating to this solicitation will be provided in writing to all prospective bidders in the form of an amendment if, in the Contracting Officer's judgment, the information is necessary to the preparation and/or submittal of proposals or lack of such information would be otherwise prejudicial to other prospective bidders. Bidders must acknowledge receipt of all amendments on the form provided.
- (c) Oral explanations, representations or instructions of any kind relating to the subject matter of this solicitation given at any time before award of the Contract by any employee, officer or agent of the Authority, will not be binding upon the Authority. The Authority does not

assume responsibility for the accuracy of any such communication.

- (d) The failure of a prospective bidder to request an explanation will serve to preclude it from claiming any ambiguity, inconsistency or error that should have been discovered by a reasonably prudent bidder.

6. PRE-BID CONFERENCE

For the purpose of clarifying the requirements of this IFB, a pre-bid conference will be held to respond to questions by prospective bidders. **This pre-bid conference will be held at 1p.m. on August 24, 2018, at WMAA/WMATA Site Office/Dulles Metrorail Yard Construction Trailer located at 44259 Old Ox Road, Sterling, VA, 20166.** It is requested that bidders submit their questions in writing, whether in advance of the meeting or during the meeting. Questions from the floor, however, are permissible.

The Pre-Bid Conference will be immediately followed by a Site Visit. Refer to Attachment D hereto for the map view of the Site Visit location.

Individuals that plan to attend the Pre-Bid Conference are required to send an email to ggufranova@wmata.com 48 hours in advance, with their name, title, company name, mailing address, telephone, and email for each attendee. Failure to submit this information may preclude the individuals from the participation in the Pre-Bid Conference and Site Visit due to advance planning required from WMATA to accommodate the personnel.

The maximum number of attendees per company is 2 individuals. Attendees will be required to provide their own transportation for the Site Visit. After meeting with WMATA point of contact attendees will be required to check in and out with the Site Safety Staff. All Site Visit attendees will be required to have with them OSHA approved safety vests - must be class III, with sleeves, hard hats, safety eye protection, and Safety boots – ankle must be protected, gloves.

7. AMENDMENTS PRIOR TO DATE SET FOR OPENING OF BIDS

- (a) The Authority reserves the right to amend any of the terms of this IFB, the proposed Contract's terms and conditions, the Scope of Work and/or drawings prior to the date set for the opening of bids. Copies of any such amendments as may be issued will be furnished in writing to all prospective bidders.
- (b) If, in the Contracting Officer's judgment, any amendment(s) would require material changes in bid quantities and/or price, the date set for bid opening may be postponed for such period that, in the Contracting Officer's opinion, will enable bidders to revise their bids. In such instances, the amendment will include an announcement of the new date for bid opening.
- (c) In the event of an amendment, all other terms and conditions of the solicitation shall remain unchanged.

8. ACKNOWLEDGMENT OF AMENDMENTS

Bidders are required to acknowledge receipt of all amendment(s) to the solicitation on the designated form to be submitted with their bid. Failure to acknowledge all amendments may cause the bid to be considered not responsive to the solicitation, which would require rejection of the bid.

9. PREPARATION OF BIDS

- a. Bids shall be submitted on the Price Schedule furnished, or copies thereof, and must be manually signed. If erasures or other changes appear on the forms, such erasures or changes must be initialed by the person signing the bid.
- b. Bidders shall furnish all information required by this IFB and, in so doing, are expected to fully examine the IFB and all attached documents. Failure to do so will be at the bidder's risk.
- c. Discounts for prompt payment will not be considered in the evaluation of bids. However, any offered discount will be included within the award of the Contract and the Authority will apply it, if payment is made within the discount period referenced in the bid.
- d. The Price Schedule may include prices for one or more items that are unit prices, lump sum bids, alternate prices, or a combination thereof. The Price Schedule expressly requires a bid on all items. Failure to do so will render the bid nonresponsive.
- e. All bid prices shall be deemed to include the cost of all work, labor and materials required by the Contract, including without limitation, delivery charges, insurance, container charges or any other expenses incidental to the work, including, but not limited to expenses associated with compliance with Federal, State or local laws or regulatory requirements. All bid prices are deemed to be F.O.B. Destination.
- f. Unless specifically permitted by the Price Schedule, alternate bids will not be considered.

10. SUBMITTAL OF BIDS

- a. Bids shall be enclosed in sealed envelopes and addressed to the office specified in the solicitation.
- b. The face of the envelope must show the hour and date specified in the solicitation for bid opening, the solicitation number, and the bidder's name and address. Failure to follow these instructions may result in a premature opening of, or a failure to open, a bid, for which, the Authority assumes no responsibility.
- c. Facsimile bids will not be considered.
- d. All bids will remain sealed until the date and time specified for the opening of bids.

11. RESPONSIVE BIDS

- a. Bidders are advised that a bid that is at variance or noncompliant with any provision of this solicitation, including a qualified or conditional bid, may be rejected as non-responsive.
- b. The Contracting Officer may reject a bid as nonresponsive if, in his or her judgment, the bid prices are materially unbalanced. Bid prices are materially unbalanced when

they are significantly understated for one (1) or more element(s) of work and significantly overstated for other element(s) of work.

- c. The Authority reserves the right to waive minor errors or omissions in a bid and to deem it responsive.

12. LATE BIDS AND MODIFICATIONS OR WITHDRAWALS PRIOR TO BID OPENING

- a. Any bid received at the office designated in the solicitation after the exact time specified for bid opening will not be considered, unless it is received before award and it:
 - (1) Was sent by registered or certified U.S. or Canadian mail not later than the fifth day before the date specified for receipt of bids (For example, a bid submitted in response to a solicitation stating that bid opening will be on the 20th of the month must have been mailed by the 15th);
 - (2) Was sent by first class mail and the Contracting Officer determines that the late receipt was due solely to the Authority's mishandling after its timely delivery on the Authority's premises;
 - (3) Was sent by U.S. Postal Service, Express Mail Next Day Service not later than 5:00 p.m. at the place of mailing at least two (2) business days prior to the date specified for opening of bids. The term "business days" excludes weekends and U.S. federal holidays; or
 - (4) Is the only bid received.
- b. Any modification or withdrawal of a bid is subject to the same conditions as set forth in subparagraphs (a) (1) through (a) (3) above.
- c. The only acceptable evidence to establish the time of the Authority's receipt is the time/date stamp of that event on the bid wrapper or other documentary evidence of receipt maintained by the Authority.
- d. Notwithstanding subparagraph (a), a late modification of any otherwise successful bid that makes its terms more favorable to the Authority will be considered at any time it is received and may be accepted.
- e. Bids may be withdrawn by written notice, received by the Authority before the opening of bids. Bids may be withdrawn in person by a bidder, or its authorized representative, if the representative's identity is established to the Contracting Officer's satisfaction and the representative signs a receipt for the return of the bid, before the opening of bids. The attempted withdrawal of a bid, received subsequent to bid opening and during the acceptance period set forth in paragraph 12, will not be honored and will be without effect.

13. BID ACCEPTANCE PERIOD AND BIDDER'S DEFAULT

- a. The acceptance period for this solicitation is ninety (90) calendar days.
- b. By submission of its bid, the bidder agrees that it shall be irrevocable and shall remain available to WMATA to award a Contract pursuant to this solicitation for not less than the acceptance period. The bidder's failure to furnish required documents and/or to execute a Contract from WMATA in accordance with its bid, during the acceptance period shall constitute a bidder's default.
- c. In the event of a bidder's default, the bidder shall be liable to WMATA for all associated damages and costs, including without limitation, WMATA's "cost to cover." The "cost to cover" is the difference between the bid price and the price WMATA ultimately pays for the work encompassed in this solicitation, whether through award of a Contract to another bidder, pursuant to this solicitation or otherwise.
- d. *Not Applicable*

14. BID GUARANTEE

Not Applicable

15. BID MISTAKE

- a. A bidder who seeks to withdraw its bid subsequent to bid opening due to a claimed mistake or error in its preparation shall notify the Contracting Officer, in writing, immediately upon realizing the mistake, but not later than three (3) business days following bid opening. Such notification must set forth the details of, and explanation for, the claimed mistake. The Contracting Officer shall evaluate the claimed mistake and determine whether the bidder will be permitted to withdraw its bid.
- b. In the event of an apparent discrepancy between any unit price and its associated extended price, the unit price will be presumed to be correct. The Contracting Officer may award a Contract to an otherwise low bidder based upon the unit price, subject to the additional terms of this article.
- c. A bidder claiming a mistake shall, at the Contracting Officer's request, appear before one (1) or more designated Authority representative(s) to provide testimony and/or documentation that may include the bidder's computation sheets and calculations, to assist in the Authority's determination.
- d. Nothing contained herein shall preclude the Contracting Officer from allowing a bidder to cure a deficiency in an otherwise responsive bid where he or she determines that such deficiency is in the nature of a minor informality or irregularity.

16. REPRESENTATIONS, CERTIFICATIONS, AND ACKNOWLEDGMENTS

All bidders shall check or complete all applicable boxes or blocks, and provide all requested information, and signatures on the attached "Representations and Certifications" form. Bidders are reminded of the obligation to fully and faithfully complete the accompanying

“Representations and Certifications” form that must be submitted with its bid. Failure to do so may result in the bid being rejected as nonresponsive.

17. LAWS AND REGULATIONS

Bidders are responsible for complying with any and all applicable State of Maryland, Commonwealth of Virginia, District of Columbia, and Federal laws and regulations governing the services to be provided under this Contract. Further, the successful bidder shall be responsible to obtain, at its own cost and expense, any and all licenses/permits required to transact business in any political jurisdictions where work will be performed.

18. ROYALTY INFORMATION

Not Applicable

19. REQUIREMENT FOR COST DATA FOR CONTRACT AWARD

The Authority may require the apparent low bidder to submit cost data in sufficient detail to permit analysis of the cost elements that comprise the bid prices. In such instances, the apparent low bid may, at the discretion of the Authority, be subject to audit.

20. PRE-AWARD INFORMATION/BIDDER RESPONSIBILITY

- (a) In order to be eligible for award of a Contract, a bidder must affirmatively demonstrate to the Contracting Officer’s satisfaction that it is responsible for purposes of this solicitation. Such demonstration must include a showing that it maintains the requisite integrity, overall technical expertise and experience, (including prior performance on other Authority contracts or contracts with other government agencies), and sufficient financial resources to perform the Contract in a timely, satisfactory and appropriate manner. Failure to so demonstrate may result in rejection of the low bidder as not responsible. In such event, the second lowest bidder will be required to demonstrate its responsibility. This process will continue until a bidder successfully demonstrates that it is responsible for purposes of Contract award.
- (b) The Contracting Officer may conduct a pre-award survey and/or take other actions to obtain information regarding the apparent low bidder’s responsibility. The apparent low bidder shall promptly supply information that the Contracting Officer requests regarding its responsibility, in such manner and form as he or she requests.
- (c) Among other items, the apparent low bidder shall furnish the following when the Contracting Officer requests:
 - (1) A completed and signed “Pre-Award Evaluation Data” form (copy attached), including all referenced financial statements and information;
 - (2) Evidence of good standing in the System for Award Management (SAM) at www.sam.gov.

- (3) Disadvantaged Business Enterprise data as set forth in Appendix B. The submittal of certain items and request for waiver (if applicable) are required if the bid is \$150,000 or greater. Failure to submit forms B-12, B-13, and/or to request waivers (if applicable) may cause the bid to be rejected. A bidder's failure to supply this information or otherwise fully cooperate with the Authority's inquiry may result in a determination that the bidder is not responsible for purposes of this solicitation and thereby ineligible for award.
- (4) Small Business Enterprise (SBE) documentation (if applicable) as set forth in Appendix B-1 – NOT APPLICABLE. The bidder's failure to supply this information or otherwise fully cooperate with the Authority's inquiry may result in a determination that the bidder is not responsible for purposes of this solicitation and thereby ineligible for award.
- (5) Resume of an individual who will be responsible for First Aid and CPR at the site to include current First Aid and CPR certificates. Refer to Attachment C for requirements.
- (6) Submit a detailed, site-specific Fall Protection Plan. Refer to Attachment C for requirements.
- (7) Provide Product data sheets indicating compliance with the performance criteria and standards included in Attachment B, including composition, finish, durability, structural adequacy, warranty, availability of replacement /additional parts, probable life of product, test results, and any ANSI/BIFMA ratings.
- (8) Insurance. The bidder shall submit as evidence of insurability a letter from an insurance agent or broker indicating that a commitment, valid for 90 days, exists from a specific insurance carrier or carriers to provide the coverages, with limits and insured as specified therein, can be bound upon award of the contract at a price known and acceptable to the bidder. Failure to establish insurability may result in a determination of non-responsibility.
- (9) Bidders shall submit a Critical Path Method (CPM) style bar chart with their Pre-Award Data showing in days/ weeks of time of award, submittal review and approvals, material lead time, shipping & delivery time, installation time and punch list time.

21. PRE-AWARD RESPONSIBILITY MEETING

The Authority reserves the right to require that a pre-award meeting be held with the apparent low bidder prior to Contract award in order to further assist the Authority in determining the bidder's responsibility for purposes of award.

22. SITE VISIT/INSPECTION OFFEROR'S FACILITIES

A successful bidder must maintain sufficient facilities that will allow it to adequately perform Contract as specified herein. WMATA may make site visits prior to Contract award to examine the bidder's facilities.

23. BASIS FOR CONTRACT AWARD

- a. Award(s) of this Contract will be made based solely on the lowest price as stated in the Price Schedule, to the bidder(s) (i) whose bid is judged to be responsive to the terms of the

solicitation and (ii) who demonstrates to the Contracting Officer's satisfaction that it is responsible for purposes of award of this Contract.

- b. Unless otherwise expressly specified in the Price Schedule, the Authority may make multiple awards as a result of this solicitation.
- c. The Authority reserves the right to reject all bids and cancel this solicitation at any time prior to award.
- d. A written award notice mailed or otherwise furnished to the successful bidder within the acceptance period shall result in a binding contract without further action by either party.

24. EQUAL EMPLOYMENT OPPORTUNITY

In order to be eligible for award of a Contract pursuant to this solicitation, the apparent low bidder will be required to comply with all applicable Equal Employment Opportunity laws and regulations.

25. PERFORMANCE/PAYMENT BONDS

NOT APPLICABLE

26. DISADVANTAGED BUSINESS ENTERPRISES REQUIREMENTS

Attached as part of this solicitation are documents outlining the requirements for the Disadvantaged Business Enterprise (DBE) Program: **The DBE requirement/goal for this Contract is Not Applicable unless a good faith waiver is requested and approved.**

- (a) If the proposal is over \$150,000, in order for the offeror to be considered responsible, the following documents (See Appendix B) shall be completed and submitted with the bid:

Schedule of DBE Participation

Letter of Intent to Perform as Subcontractor/Joint Venturer
(If applicable)

DBE Unavailability Certification
(Where applicable)

Written request for waiver, when DBE participation is less than stated percentage.

- (b) If this Contract involves a Small Business Enterprise (SBE) set-aside, the provisions of Appendix B-1 are applicable. Appendix B-1 forms must be completed by each bidder to insure that its bid is acceptable.

The provisions of Appendix B (if attached) do not become applicable and forms do not have to be completed, unless the total bid price is \$150,000 or more. If the bid is \$150,000 or more and any portion of the submittal requirement is omitted, then the bid may be found to be unacceptable and subsequently rejected. Appendix B forms and/or waivers must be completed with great care by each bidder to ensure that its bid is acceptable.

27. OPPORTUNITY FOR DISADVANTAGED BUSINESS ENTERPRISES TO BID

The Washington Metropolitan Area Transit Authority hereby notifies all prospective bidders that it will affirmatively ensure that disadvantaged minority business enterprises will be afforded full opportunity to submit bids in response to this solicitation and will not be discriminated against on the basis of race, color, creed, sex, religion, national origin, disability, sexual preference and/or gender identity in consideration for award.

28. NOTICE OF PROTEST POLICY

- (a) The Authority's procedure for the administrative resolution of protests is set forth in Chapter 17 of WMATA's Procurement Procedures Manual (PPM). The procedures contain strict rules for filing a timely protest, for responding to a notice that a protest has been filed, and other procedural matters.
- (b) The basis on which FTA will review a grantee's protest decision is defined in §17-8. FTA will generally exercise discretionary jurisdiction over cases deemed to involve issues important to the overall third party contracting program. FTA's decision to decline jurisdiction over a protest does not imply approval of or agreement with the agency's decision or that FTA has determined that this Contract is eligible for Federal participation.
- (c) Alleged violations must be submitted to the Contracting Officer who will administratively decide the protest.
- (d) The United States District Courts for the Districts of Maryland, Virginia and the District of Columbia, and the local courts in Maryland, Virginia and the District of Columbia have jurisdiction over court actions concerning protest decisions.

29. WMATA'S TAX EXEMPT STATUS

- (a) Pursuant to Article XVI, Paragraph 78, of the Washington Metropolitan Area Transit Authority's Compact, as adopted by the State of Maryland, the District of Columbia, and the Commonwealth of Virginia, with the authorization and consent of the Congress of the United States, the Authority has been accorded exemption from taxes as follows:
 - "The Authority and the Board shall not be required to pay taxes or assessments upon any of the property acquired by it or under its jurisdiction, control, possession or supervision, or upon its activities in the operation and maintenance of any transit facility or upon any revenues therefrom, and the property and income derived therefrom shall be exempted from all Federal, State, District of Columbia, municipal, and local taxation. This exemption shall include without limitation, all motor vehicle license fees, sales taxes and motor fuel taxes."
- (b) By submission of its bid, the bidder certifies that none of the taxes that the Authority is exempt from are included therein.

30. ENGLISH LANGUAGE AND UNITED STATES CURRENCY

With respect to both this solicitation and the resultant Contract:

- (a) All communications (oral, written, electronic and otherwise including but, not limited to, software coding) shall be in the English language.
- (b) All pricing shall be in United States dollars.

31. BRAND NAME OR EQUAL

- (a) If items called for by this IFB have been identified in the Price Schedule by a "brand name or equal" description, such identification is intended to be descriptive, but not restrictive, and is to indicate the quality and characteristics of products that will be satisfactory. Bids offering "equal" products, including products of the brand name manufacturer, other than the one described by brand name will be considered for award, if such products are clearly identified in the bids and the Authority determines that they fully meet the salient characteristics (physical, functional, or performance) requirements in the IFB.
- (b) Unless the bidder clearly indicates in its bid that it is offering an "equal" product, the bid shall be considered as offering a brand name product referenced in the IFB.
- (c) If the bidder proposes to furnish an "equal" product, a description of the product to be furnished shall be placed in the space provided in the IFB, or such product shall be otherwise clearly identified in its bid. The Authority, at its sole discretion, must be able to determine equality *without an extensive evaluation*. Thus, if the bidder has some information demonstrating equality of the proposed equal, such as acceptance by another transit agency, it should submit such documentation with its bid.
- (d) CAUTION TO BIDDERS. WMATA is not responsible for locating or securing any information that is not identified in its bid and reasonably available to the Authority. The offeror must furnish as a part of its proposal all descriptive material (such as cuts, illustrations, drawings, or other information) necessary for the Authority's determination.
- (e) The information furnished may incorporate by specific reference, information previously furnished or otherwise available to the Authority.

32. REQUESTS FOR RECORDS

The Washington Metropolitan Area Transit Authority (WMATA), in the regular course of business, may receive from the public, including prospective vendors and bidders, requests for records on a variety of topics. It is WMATA's policy to make official agency records, including electronic records, available to the public, unless specifically prohibited by WMATA's policy or applicable laws.

- (a) "Records" means any existing writings, drawings, maps, recordings, tapes, film, microfilm, correspondence, forms, cards, photographs, optical disks, photo copies, and records stored by computer (electronic records) that are made or received by WMATA in connection with a public contract. A record does not include uncirculated personal notes, papers, electronic records and any other records that were created and retained solely as work papers for personal use of the Contracting Officer, Contract Administrator or other WMATA employee.

- (b) WMATA's contracting process allows for the release/posting of certain information concerning this Contract after its award. This includes the name of the successful bidder and the amount of the award. This information is available on WMATA's website under "Business with Metro" or directly from the Contract Administrator.
- (c) Upon WMATA's request, the successful bidder shall be required to provide a redacted copy of its bid with confidential and proprietary information redacted.
- (d) After the award is announced, the winning proposal may be subject to release under WMATA's Public Access to Records Policy (PARP).
- (e) When WMATA determines that a bid will be of wide public interest, WMATA will post the redacted bid on its website. When WMATA receives three (3) or more requests for a successful bid, WMATA will post it on its website.
- (f) Requests for Records that are not made available during the procurement process will be submitted in accordance with the PARP. Requests must be in writing and sent by mail to the Office of General Counsel, Washington Metropolitan Area Transit Authority, 600 Fifth Street, NW, Washington, D.C. 20001, or by electronic mail at parpprivreq@wmata.com or by facsimile to the attention of the PARP Administrator at (202) 962-2550. If a request for records is sent directly from the requestor to a Contract Administrator, department, or independent office, that entity shall immediately forward the request to the PARP Administrator in the Office of General Counsel. If records are subject to a PARP request, a member of the PARP team will contact the company to begin the PARP document review process, which includes providing detailed written justifications for any information for which exemptions are claimed.
- (g) Neither WMATA's bidding process nor the PARP process generally allow for the release of information that would cause competitive harm to the bidders, other organizations, WMATA's employees, or interests. Information that will be withheld includes the following:
 - (1) The names of unsuccessful bidders;
 - (2) The bids of unsuccessful bidders;
 - (3) Personal information (this does not include education and qualifications which are released) about the successful bidder or its employees that is not available to the public on the website of the successful bidder;
 - (4) Unit price details of the successful bid (this does not include the bottom line price, which is released);
 - (5) The names of the vendors who file a protest to the solicitation or its award;
 - (6) The written adjudication of any protests;
 - (7) Personal information concerning WMATA's employees; and
 - (8) Trade secrets and confidential commercial or financial information obtained from a bidder.
- (h) If your company's records are subject to a PARP request (i.e., if it is the successful bidder), a broad claim of confidentiality for the entire bid is rarely acceptable, and will likely be rejected during the PARP process. Therefore, WMATA suggests that you narrowly identify your confidential/proprietary information based on the following guidance:

- (i) Information that may be withheld/redacted: Detailed pricing except bottom line offer amounts;

- (j) Public information subject to release:
 - (1) Any information on your company's website;
 - (2) Publicly known information (even if not on your company's website);
 - (3) General company background;
 - (4) Mere compliance with IFB requirements; and
 - (5) Anything standard to the industry.

REPRESENTATIONS & CERTIFICATIONS

Instructions: Check or complete all applicable boxes or blocks on this form and submit it with your offer.

1. TYPE OF BUSINESS ORGANIZATION

By submission of this offer, the offeror represents that it operates as an individual, a partnership, a limited liability company, a joint venture, a nonprofit organization, or a corporation, incorporated under the laws of the State of _____.

Name	Signature
Title	Company
Date	

2. AFFILIATION AND IDENTIFYING DATA

Each offeror shall complete 2.1, 2.2 if applicable, and 2.3 below, representing that:

2.1 It is, is not, owned or controlled by a parent company. For this purpose, a parent company is defined as one that either owns or controls the activities and basic business policies of the offeror. To own another company, means that the parent company must own at least a majority, i.e., more than fifty percent (50%), of the voting rights in that company. To control another company, such ownership is not required. If another company is able to formulate, determine or veto the offeror's basic business policy decisions, such other company is considered the parent of the offeror. This control may be exercised through the use of dominant minority voting rights, use of proxy voting, Contractual arrangements or otherwise.

2.2 If the offeror is owned or controlled by a parent company, it shall insert in the space below the name and main office address of the parent company:

 Name of Parent Company

 Main Office Address (including ZIP Code)

2.3 If the offeror has no parent company, it shall provide in the applicable space below its own employer's identification number (E.I.N.), (i.e., number used on Federal tax returns or, if it has a parent company, the E.I. N. of its parent company).

Offeror E.I. N.: _____ or, Parent Company's E.I. N.: _____

Name	Signature
Title	Company
Date	

3. PREVIOUS CONTRACTS AND COMPLIANCE REPORTS

This representation is applicable to federally assisted contracts. By submission of this offer, the offeror represents that:

- 3.1** It [] has, [] has not, participated in a previous contract or subcontract subject to either the Equal Opportunity Clause of this solicitation, or the clause contained in Parts II and IV of Executive Order 11246, as amended; that prohibits discrimination on the basis of race, color, creed, national origin, sex, age; and
- 3.2** It [] has, [] has not, filed all required compliance reports; and
- 3.3** Representations indicating submittal of required compliance reports signed by proposed subcontractors will be obtained prior to subcontract awards.

Name	Signature
Title	Company
Date	

4. DISADVANTAGED BUSINESS ENTERPRISE

This representation is applicable to federally assisted contracts. By submission of this offer, the offeror represents that:

- 4.1** It [] is, [] is not, a disadvantaged business enterprise.

"Disadvantaged Business Enterprise" means a for-profit small business concern that is at least fifty one percent (51%) owned by one or more individuals who are both socially and economically disadvantaged individuals or, in the case of a corporation, in which fifty one percent (51%) of the stock is owned by one or more such individuals; and whose management and daily business operations are controlled by one or more socially and economically disadvantaged individuals who own it.

"Socially and Economically Disadvantaged Individual" is defined in Appendix B. Notice of Requirements for Disadvantaged Business Enterprise (DBE). By submission of this offer, the offeror represents that:

- 4.2** It [] is, [] is not, currently certified by Metropolitan Washington Unified Certification Program (MWUCP) as a disadvantaged business enterprise.
- 4.3 **Special Certification Requirements for Transit Vehicle Manufacturers.**** Each transit vehicle manufacturer, as a condition of being authorized to bid or propose on FTA funded transit vehicle procurements, must certify that it has complied with the DBE requirements of 49 C.F.R. Part 26.

The offeror represents that it [] is or [] is not a transit vehicle manufacturer and [] has or [] has not complied with the DBE requirements of 49 C.F.R Part 26.

Name	Signature
Title	Company
Date	

5. SMALL BUSINESS ENTERPRISE (MAY 2015)

“Small Business Enterprise” means a for profit small business concern that is at least fifty one percent (51%) owned by one (1) or more individual(s) who are economically disadvantaged. “Economically Disadvantaged Individual” is defined in Appendix B-1, Definitions, in Notice of Requirements for Small Business Enterprise (SBE) Program.

5.1 It is, is not, a small business enterprise. A firm must be a small business as defined by the U.S. Small Business Administration (SBA) by applying current SBA business size standards found in 13 C.F.R. Part 121 that are applicable to the type of work the firm seeks to perform in USDOT assisted contracts. The fifty one percent (51%) owner must be a U.S. citizen or permanent resident. A firm must be organized for profit in order to be eligible for SBE certification. The firm’s average gross receipts cannot exceed the overall USDOT size standard for a small business [\$23.98 million averaged over the three (3) previous fiscal years or part of year that the business has been in existence.] Set forth in 49 C.F.R. § 26.65, at least fifty one percent (51%) of the firm’s ownership must be held by individuals who meet the personal net worth (PNW) cap of \$1.32 million as prescribed by 49 C.F.R. § 26.67.

5.2 It is, is not, currently certified by WMATA as a small business enterprise.

Name	Signature
Title	Company
Date	

6. AFFIRMATIVE ACTION COMPLIANCE

This representation is applicable to federally assisted contracts of \$50,000 or more that are awarded to contractors with fifty (50) or more employees. By submission of this offer, the offeror represents that:

- 6.1** It has a workforce of _____ employees.
- 6.2** It has developed and has on file, or has not developed and does not have on file, at each establishment, affirmative action programs required by the rules and regulations of the Secretary of Labor (41 C.F.R. §§ 60.1 and 60.2), or
- 6.3** It has not previously had contracts subject to the written affirmative action program requirements of the rules and regulations of the U.S. Secretary of Labor.

Name	Signature
Title	Company
Date	

7. COVENANT AGAINST GRATUITIES

By submission of this offer, the offeror certifies, and in the case of a joint offer, each party thereto certifies as to its own organization, that in connection with this procurement:

Neither it nor any of its employees, representatives or agents have offered or given gratuities (in the form of entertainment, gifts or otherwise) to any Board member, employee or agent of the Authority with the view toward securing favorable treatment in the awarding, or administration of this Contract.

Name	Signature
Title	Company
Date	

8. CONTINGENT FEES

By submission of this offer, the offeror certifies, and in the case of a joint offer, each party thereto certifies as to its own organization, that in connection with this procurement:

- 8.1** It [] has, [] has not, employed or retained any company or persons (other than a full-time, bona fide employee working solely for the offeror) to solicit or secure this Contract, and
- 8.2** It [] has, [] has not, paid or agreed to pay any company or person (other than a full-time, bona fide employee working solely for the offeror) any fee, commission, percentage, or brokerage fee contingent upon or resulting from the award of this Contract.

Name	Signature
Title	Company
Date	

9. CLEAN AIR ACT AND CLEAN WATER ACT CERTIFICATION

This certification is applicable if the Contract will be federally assisted and the offer exceeds \$150,000, or the Contracting Officer believes that orders under an indefinite type Contract in any year will exceed \$150,000 or a facility to be used has been the subject of a conviction under the Clean Air Act [42 U.S.C. § 7413(c)(1)] or the Clean Water Act [33 U.S.C. § 1319(c)], is listed by the U.S. Environmental Protection Agency (EPA) as a violating facility, and the acquisition is not otherwise exempt:

- 9.1** Any facility to be utilized in the performance of this Contract [] is, or [] is not listed on the EPA's List of Violating Facilities;
- 9.2** Offeror will immediately notify the Contracting Officer, before award, of the receipt of any communications from the Administrator, or a designee of the EPA, indicating that any facility that it proposes to use in the performance of this Contract is under consideration to be listed on the EPA's List of Violating Facilities; and
- 9.3** Offeror will include a certification substantially the same as this certification, including this paragraph, in every non-exempt subcontract.

Name	Signature
Title	Company
Date	

10. DEBARMENT, SUSPENSION, INELIGIBILITY, AND VOLUNTARY EXCLUSION

This certification is applicable to federally assisted contracts over \$25,000.

10.1 Primary Covered Transactions. This certification applies to the offer submitted in response to this solicitation and will be a continuing requirement throughout the term of any resultant Contract.

10.1.1 In accordance with the provisions of 2 C.F.R. Part 1200 and 2 C.F.R. Part 180, Subpart C, the offeror certifies to the best of its knowledge and belief that it and its principals:

10.1.1.1 are not currently debarred, suspended, proposed for debarment, declared ineligible, or voluntarily excluded from covered transactions by any Federal or state department or agency;

10.1.1.2 have not, within a three (3) year period preceding this offer, been convicted of or had a civil judgment rendered against them for commission of fraud or a criminal offense in connection with obtaining, attempting to obtain, or performing a public (Federal, state, or local) transaction or contract under a public transaction; violation of Federal or state antitrust statutes, or commission of embezzlement, theft, forgery, bribery, falsification or destruction of records, making false statements, or receiving stolen property;

10.1.1.3 are not currently indicted for or otherwise criminally or civilly charged by a governmental entity (Federal, state, or local) with commission of any of the offenses enumerated in paragraph (1) (ii) of this certification; and have not, within a three (3) year period preceding this offer, had one (1) or more public transactions (Federal, state, or local) terminated for cause or default.

10.1.2 Where the offeror is unable to certify to any of the statements in this certification, the offeror shall attach an explanation to this offer.

10.2 Lower Tier Covered Transactions. This certification applies to a subcontract at any tier expected to equal or exceed \$25,000 and will be a continuing requirement throughout the term of this Contract.

10.2.1 The prospective lower tier subcontractor certifies, by submission of this offer, that neither it nor its principals is currently debarred, suspended, proposed for debarment, declared ineligible, or voluntarily excluded from participation in this transaction by any Federal or state department or agency.

10.2.2 Where the prospective lower tier subcontractor is unable to certify to any of the statements in this certification, such prospective participant shall attach an explanation to this proposal.

10.3 The Certification required by 10.2, above, shall be included in all applicable subcontracts and the Contractor shall keep a copy on file. The Contractor shall be required to furnish copies of certifications to the Contracting Officer upon his or her request.

Name	Signature
Title	Company
Date	

11. CERTIFICATION OF INDEPENDENT PRICE DETERMINATION

11.1 By submission of its offer, the offeror certifies, and in the case of a joint offer, each party thereto certifies as to its own organization, that in connection with this procurement:

11.1.1 The prices in this offer have been arrived at independently, without, for the purpose of restricting competition, any consultation, communication, or agreement with any other offeror or with any other competitor;

11.1.2 Unless otherwise required by law, the prices that are quoted in this offer have not been knowingly disclosed by the offeror and will not be knowingly disclosed by the offeror prior to award (in the case of a negotiated procurement), directly or indirectly, to any other offeror or to any competitor; and

11.1.3 No attempt has been made or will be made by the offeror to induce any other person or firm to submit or not to submit an offer, for the purpose of restricting competition.

11.2 Each person signing this offer certifies that:

11.2.1 He or she is the person in the offeror's organization responsible for the decision regarding the prices being offered herein and that he/she has not participated, and will not participate, in any action contrary to 11.1.1 through 11.1.3 above; or

11.2.2 He or she is not the person in the offeror's organization responsible for the decision regarding the prices being offered herein, but that he/she has been authorized in writing to act as agent for the persons responsible for such decision in certifying that such persons have not participated; and will not participate, in any action contrary to 11.1.1 through 11.1.3 above; or and as their agent he or she does hereby so certify.

Name	Signature
Title	Company
Date	

12. CERTIFICATION OF NONSEGREGATED FACILITIES

This certification is applicable to federally assisted contracts over \$10,000.

- 12.1** By submission of this offer, the offeror certifies, and in the case of a joint offer, each party thereto certifies as to its own organization, that in connection with this procurement:
 - 12.1.1** It does not and will not maintain or provide for its employees, any segregated facilities at any of its establishments, and that it does not and will not permit its employees to perform their services at any location under its control, where segregated facilities are maintained.
 - 12.1.2** The offeror agrees that a breach of this certification is a violation of the Equal Opportunity clause in this Contract.
 - 12.1.3** As used in this certification, the term "segregated facilities" means any waiting rooms, work areas, rest rooms and wash rooms, restaurants and other eating areas, time clocks, locker rooms and other storage or dressing areas, parking lots, drinking fountains, recreation or entertainment areas, transportation, and housing facilities provided for employees that are segregated by explicit directive or are in fact segregated on the basis of race, color, religion or national origin, because of habit, local custom or otherwise.
 - 12.1.4** It further agrees that (except where it has obtained identical certifications from proposed subcontractors for specific time periods) it will:
 - 12.2** Obtain identical certifications from proposed subcontractors before the award of subcontracts under which the subcontractor will be subject to the Equal Opportunity clause;
 - 12.3** Retain such certifications in its files; and
 - 12.4** Forward the following notice to such subcontractors (except if the proposed subcontractors have submitted identical certifications for specific time periods):

NOTICE TO PROSPECTIVE SUBCONTRACTORS OF REQUIREMENTS FOR CERTIFICATIONS OF NONSEGREGATED FACILITIES

A Certification of Nonsegregated Facilities must be submitted prior to award of a subcontract exceeding \$10,000 that is not exempt from the provisions of the Equal Opportunity clause. The certification may be submitted either for such subcontract or for all subcontracts during a period (i.e., quarterly, semiannually or annually).

Name	Signature
Title	Company
Date	

13. NONDISCRIMINATION ASSURANCE

- 13.1** By submission of this offer, the offeror certifies, and in the case of a joint offer, each party thereto certifies as to its own organization, in connection with this procurement, that it will not discriminate on the basis of race, color, creed, religion, national origin, sex, age, disability, sexual preference and/or gender identity in the performance of this Contract. The offeror is required to insert the substance of this clause in all subcontracts and purchase orders. The Contractor's failure to carry out these requirements is a material breach of this Contract, that may result in the termination of this Contract or such other remedy as the Authority deems

appropriate. The offeror further agrees by submitting this offer, that it will include this certification, without modification, in all subcontracts and purchase orders.

Name	Signature
Title	Company
Date	

14. CERTIFICATION OF RESTRICTIONS ON LOBBYING

This certification is applicable to federally assisted contracts if the offer exceeds \$100,000.

14.1 By submission of this offer, the offeror certifies, and in the case of a joint offer, each party thereto certifies as to its own organization, that to the best of his or her knowledge or belief:

14.1.1 No federally appropriated funds have been paid or will be paid, by or on behalf of the undersigned, to any person for influencing or attempting to influence an officer or employee of an agency, a member of Congress, an officer or employee of Congress, or an employee of a member of Congress in connection with the awarding of any Federal contract, the making of any Federal grant, the making of any Federal loan, the entering into of any cooperative agreement, and the extension, continuation, renewal, amendment, or modification of any Federal contract, grant, loan, or cooperative agreement.

14.1.2 If any funds other than federally appropriated funds have been paid or will be paid to any person for making lobbying contacts to an officer or employee of any agency, a member of Congress, an officer or employee of Congress, or an employee of a member of Congress in connection with this Contract, the undersigned shall complete and submit Standard Form--LLL, "Disclosure of Lobbying Activities."

14.1.3 The undersigned shall require that the language of this certification be included in all sub-awards (including subcontracts, sub-grants and contracts under grants, loans and cooperative agreements) at all tiers and that all sub-recipients shall certify and disclose accordingly.

14.2 This certification is a material representation of fact upon which reliance was placed when this transaction was made or entered. Submission of this certification is a prerequisite for making or entering into this transaction imposed by 31 U.S.C. § 1352, as amended. Any person who fails to file the required certification shall be subject to a civil penalty of not less than \$10,000 and not more than \$100,000 for each such failure.

14.3 The Contractor certifies or affirms the truthfulness and accuracy of each statement of its certification and disclosure, if any. In addition, the Contractor understands and agrees that the provisions of 31 U.S.C.A. § 3801, *et. seq.* apply to this certification and disclosure, if any.

Name	Signature
Title	Company
Date	

15. BUY AMERICA ACT CERTIFICATION

The Buy America Act requirements apply to federally assisted construction contracts, and acquisition of goods or rolling stock contracts valued at more than \$150,000.¹

15.1 By submission of this offer, the offeror certifies, and in the case of a joint offer, each party thereto certifies as to its own organization, that in connection with this procurement it will comply with 49 U.S.C. § 5323(j) and 49 C.F.R. Part 661, which provide that Federal funds may not be obligated unless steel, iron, and manufactured products used in FTA funded projects are produced in the United States, unless a waiver has been granted by FTA or the product is subject to a general waiver. General waivers are listed in 49 C.F.R. § 661.7 Separate requirements for rolling stock are set out at 49 U.S.C. § 5323(j)(2)(C) and 49 C.F.R. § 661.11.

15.2 An offeror must submit to the Authority, the appropriate Buy America Act certification (below) with all offers on FTA funded contracts, except those subject to a general waiver. Offers that are not accompanied by a completed Buy America Act certification must be rejected as nonresponsive. This requirement does not apply to lower tier subcontractors. Mark the applicable certifications below:

15.2.1 Certification requirement for procurement of steel, iron, or manufactured products:

Certificate of Compliance with 49 U.S.C. § 5323(j)(1)
 The offeror hereby certifies that it will meet the requirements of 49 U.S.C. § 5323(j)(1) and the applicable regulations in 49 C.F.R. § 661.5.

Certificate of Non-Compliance with 49 U.S.C. § 5323(j)(1)
 The offeror hereby certifies that it cannot comply with the requirements of 49 U.S.C. § 5323(j)(1) and 49 C.F.R. § 661.5, but it may qualify for an exception pursuant to 49 U.S.C. §§ 5323(j)(2)(A), 5323(j)(2)(B), or 5323(j)(2)(D), and 49 C.F.R. § 661.7.

15.2.2 Certification requirement for procurement of buses, other rolling stock and associated equipment:

Certificate of Compliance with 49 U.S.C. § 5323(j)(2)(C)
 The offeror hereby certifies that it will comply with the requirements of 49 U.S.C. § 5323(j)(2)(C) and the regulations at 49 C.F.R. § 661.11.

Certificate of Non-Compliance with 49 U.S.C. 5323(j)(2)(C)
 The offeror hereby certifies that it cannot comply with the requirements of 49 U.S.C. § 5323(j)(2)(C) and 49 C.F.R. § 661.11, but may qualify for an exception pursuant to 49 U.S.C. §§ 5323(j)(2)(A), 5323(j)(2)(B), or 5323(j)(2)(D), and 49 C.F.R. § 661.7.

Name	Signature
Title	Company
Date	

16. CERTIFICATION OF NON-DELINQUENT TAXES

¹ If the funding for this Contract comes from an FTA grant issued before December 26, 2014, then the limit is \$100,000.

This certification is applicable to federally assisted contracts.

- 16.1** By submission of this offer, the offeror certifies, and in the case of a joint offer, each party thereto certifies as to its own organization, that in connection with this procurement:
- 16.1.1** It has not been convicted over the past three (3) years of violating any Federal criminal tax law or failed to pay any tax.
 - 16.1.2** It has certified if it has been notified of an unresolved tax lien or any unsatisfied Federal tax delinquency in excess of \$3,000 and that it is paying tax debts through an installment agreement or has requested a collections due process hearing.
 - 16.1.3** The offeror agrees that a breach of this certification is a violation of the Federal Acquisition Regulation (FAR).
 - 16.1.4** As used in this certification, the term "tax delinquency" means an outstanding debt for which a notice of lien has been filed in public records.
 - 16.1.5** It further agrees that (except where it has obtained identical certifications from proposed subcontractors for specific time periods) it will:
 - 16.2** Obtain identical certifications from proposed subcontractors before the award of subcontracts under which the subcontractor will be subject to the FAR.;
 - 16.3** Retain such certifications in its files; and
 - 16.4** Forward the following notice to such subcontractors (except if the proposed subcontractors have submitted identical certifications for specific time periods):

NOTICE TO PROSPECTIVE SUBCONTRACTORS OF REQUIREMENTS FOR CERTIFICATION OF NON-DELINQUENT TAXES

A Certification of Non-Delinquent Taxes must be submitted prior to award of a subcontract exceeding \$100,000 that is not exempt from the provisions of the FAR. The certification may be submitted either for such subcontract or for all subcontracts during a period (i.e., quarterly, semiannually or annually).

Name	Signature
Title	Company
Date	

17. DISCLOSURES OF INTERESTS OF WMATA BOARD MEMBERS

For purposes of this disclosure, terms in bold are defined by the Code of Ethics for Members of the WMATA Board of Directors a copy of which is available at www.wmata.com. Financial interests include ownership interests and prospective and actual income. Firm includes parents, subsidiaries and affiliates.

By submission of this offer, the offeror certifies, and in the case of a joint offer, each party thereto certifies as to its own organization, that to the best of its knowledge, information and belief in connection with this procurement:

17.1 [] No WMATA **Board member, household member or business associate** has a financial interest in this firm, in a **financial transaction** with the Authority to which this firm is a party or prospective party, or in an **actual or prospective business relationship with the Authority** to which this firm is a party.

17.2 [] The following WMATA **Board member(s), household member(s) or business associate(s)** has a financial interest in this firm, in a **financial transaction** with the Authority to which this firm is a party or prospective party, or in an **actual or prospective business relationship with the Authority** to which this firm is a party, Include in "Nature of Interest" below, a description of the financial interest and (1) for ownership interests, the value of the interest, the name and address of the firm in which the interest is held, and the total equity or equivalent interest of the firm; and (2) for income, the amount of all income received by the **Board member, household member or business associate** in the current and preceding fiscal year for services provided, and the name and address of the firm from which the income was received.

Name of Board Member Household Member or Business Associate	Nature of Interest
_____	_____
_____	_____
_____	_____

17.3 The certification required by 17.1 and 17.2 above shall be included in all subcontracts. The prime contractor shall furnish copies of certifications to the Contracting Officer and retain a copy for inspection upon his or her request.

Name	Signature
Title	Company
Date	

18. CRIMINAL BACKGROUND SCREENING CERTIFICATION (QUARTERLY)

By submission of this offer, the offeror certifies that:

18.1 It will contract with or engage a reputable third-party vendor to conduct, criminal background screenings of all Contractor personnel who will have access to WMATA's customers, WMATA's property, or WMATA's information in connection with this Contract. This requirement also applies to Contractors who engage with the general public on WMATA's behalf.

18.2 It will screen for criminal convictions, taking into consideration (1) the nature of the services or work being performed under the contract with particular regard for the individual's access to, and interaction with, WMATA's customers, property, and confidential information; (2) the nature or gravity of the offense or conduct resulting in a criminal conviction; and (3) the time that has lapsed since the conviction and/or completion of the sentence, all Contractor personnel who will have access to WMATA's customers, the general public, WMATA's property, or WMATA's information and who work on this Contract during each calendar year within this Contract's period of performance. The Offeror will provide certification that it conducted these screenings

to the Contracting Officer's Technical Representative (COTR) on a quarterly basis, on a form provided.

- 18.3** The Contractor shall submit to the COTR, a list of all employees and agents who will require Contractors' access badges not less than 7 days prior to the date on which access will be required.
- 18.4** The Offeror will determine that all Contractor personnel working on this Contract during the calendar year passed the Contractor's criminal background screening and will be in good standing and otherwise fit to work on this Contract.
- 18.5** The Offeror has not obtained or otherwise been made aware of any information about any Contractor personnel working on this Contract that contradicts or otherwise impacts the Contractor's determination that such persons passed the Contractor's criminal background screening and/or are fit to work on this Contract.
- 18.6** The Contractor will flow this requirement down to all of its subcontractors who will have access to WMATA's customers, the general public, WMATA's property, or WMATA's information within this Contract's period of performance.

Name	Signature
Title	Company
Date	

19. CERTIFICATION REQUIRED FOR ALL SAFETY-SENSITIVE² CONTRACTS.

- 19.1** By submission of this offer, the offeror represents and certifies that it will comply with the Federal Transit Administration (FTA) regulations, "Prevention of Alcohol Misuse and Prohibited Drug Use in Transit Operations," 49 C.F.R. Part 655, and applicable provisions of the U.S. Department of Transportation (DOT) regulations, "Procedures for Transportation Workplace Drug and Alcohol Testing Programs," 49 C.F.R. Part 40.
- 19.2** Offeror agrees that its employees and agents, including but not limited to, safety-sensitive subcontractors will be enrolled in a drug and alcohol testing program that meets the policy and procedural requirements listed in Appendix A of this document.
- 19.3** Offeror understands that Washington Metropolitan Area Transit Authority (WMATA) will perform oversight during the contract's period of performance to ensure that the successful offeror complies with the DOT/FTA regulations.
- 19.4** Failure to comply with this certification may result in WMATA issuing sanctions and pursuing available contractual remedies.

Name	Signature
Title	Company
Date	

² See the Combined Glossary for a definition of "safety-sensitive."

--	--

PRE-AWARD EVALUATION DATA

PROJECT DESCRIPTION: _____

1. Name of firm _____

2. Address: _____

3. [] Individual [] Partnership [] Corporation [] Joint Venture

4. Date organized _____.

State where incorporated or organized _____.

5. Names of officers or partners:

a. _____

b. _____

c. _____

d. _____

e. _____

f. _____

6. How long has your firm been in business under its present name?

7. Attach as Schedule One (1) a list of similar current contracts that demonstrate your firm's technical proficiency, each with contract amount, name of contracting party, character or type of work and percentage of completion.

8. Attach as Schedule Two (2) a list of similar contracts, each with contract amount, name of contracting party, and character or type of work for similar contracts completed in the last two (2) years.

9. In the last two (2) years has your firm been denied an award where it was the offeror?

If the answer is yes, attach as Schedule Three (3) the full particulars regarding each occurrence.

10. Has your firm failed to complete, in the last two (2) years, any contract on which it was the offeror?

If the answer is yes, attach as Schedule Four (4), the full particulars regarding each occurrence.

11. Financial resources available as working capital for the Contract:

- a. Cash on hand: \$ _____
- b. Sources of credit: _____
- 12. Attach as Schedule Five (5) financial statements and letters from banks regarding credit as required by the "Pre-Award Information" article.
- 13. What percentage of work (Contract amount) does your firm intend performing with its own personnel? %.
- 14. Attach as Schedule Six (6), a list of all principal subcontractors and the percentage and character of work (Contract amount) that each will perform. Principal items of work shall include, but not be limited to, those items listed in the "Pre-Award Information" article.
- 15. If the Contractor or subcontractor is in a joint venture, submit "Pre-Award Evaluation Data" forms for each member of the joint venture.

The above information is confidential and will not be divulged to any unauthorized personnel.

The undersigned certifies to the accuracy of all information.

COMPANY: _____
SIGNATURE: _____
NAME: _____
TITLE: _____
DATE: _____

TERMS AND CONDITIONS

CHAPTER I – TERMS AND CONDITIONS

1. AGREEMENT

The work to be performed under this Contract may briefly be described as delivery and installation of the rack shelving units___, including all necessary or incidental work, labor and materials. The Contractor agrees to perform the work in accordance with requirements and terms and conditions hereinafter set forth in this Contract. In consideration for the Contractor’s complete, satisfactory and proper performance of the Contract, the Authority agrees to pay to the Contractor, and the Contractor agrees to accept as full compensation, the sums of money set forth in the Price Schedule at the time and in the manner and upon the terms and conditions set forth in this Contract.

2. ARRANGEMENT OF CONTRACTUAL PROVISIONS

For ease of reference, this Contract is divided into chapters, articles (also referred to as “clauses”), paragraphs and subparagraphs. While the chapters and articles are titled, it is understood that both the use of such titles and the manner and overall arrangement of the Contractual provisions are intended solely for the convenience of the parties and are without independent Contractual or legal significance.

3. ORDER OF PRECEDENCE

(a) Any inconsistency in the Contract shall be resolved by giving precedence to the following order: (a) terms and conditions (b) the specifications or Scope of Work; (c) drawings, if any; (d) other documents, exhibits, and attachments generated by the Authority as part of this Contract; (e) the technical proposal, if any, and other Contractor submissions generated as part of this Contract. In the event of a conflict within or between provisions entitled to equal precedence, the more stringent requirement shall apply.

(b) Notwithstanding paragraph (a), if this Contract is funded, in whole or part, through the Federal Government, all contract terms mandated for inclusion by the Federal Government shall be deemed to supersede any other conflicting or inconsistent provisions of this Contract.

4. REQUIREMENTS CONTRACT Not Applicable

5. INDEFINITE QUANTITY CONTRACT Not Applicable

**6. ORDERING
Not Applicable**

7. ORDER LIMITATIONS

Not Applicable

8. AUDIT, AVAILABILITY, AND INSPECTION OF RECORDS- FTA

(a) Authorized persons. The Contracting Officer and his or her representatives, including representatives of the Authority’s governing jurisdictions and any other Federal, state, or local entity providing funding for this Contract and the U.S. Comptroller General shall have access and inspection rights described in this article.

- (b) Examination of costs. The Contractor shall maintain, and the Contracting Officer shall have the right to examine and audit, all records sufficiently to properly reflect all costs incurred or anticipated to be incurred directly or indirectly in performance of this Contract. This right of examination shall include inspection of the Contractor's facilities engaged in performing this Contract at all reasonable times.
- (c) Cost or pricing data. If the Contractor is required to submit cost or pricing data in connection with any pricing action relating to this Contract, the Contracting Officer shall have the right to examine and audit all of the Contractor's records related to: (1) any bid for this Contract, subcontract, or modification; (2) any clarifications of the bid; (3) pricing of this Contract, subcontract or modification; or (4) performance of this Contract, subcontract or modification.
- (d) Availability. The accounts, records and cost information required to be originated under this Contract, and together with all other accounts, records and cost information related to this Contract, shall be maintained and made available by the Contractor and subcontractor(s):
 - (1) At their offices at all reasonable times for inspection, audit, reproduction or such other purposes as the Contracting Officer or by anyone he or she authorizes may require or pursuant to any other provision of this Contract; and
 - (2) Except to the extent otherwise expressly set forth in this Contract, until three (3) years from the date of final payment under this Contract. If the Contract is completely or partially terminated, such records shall be maintained for a period of three (3) years from either the date of any resulting final settlement or the date of final payment, whichever is later. If a pricing adjustment is involved in any dispute or litigation related to this Contract, such records shall be maintained for a period equal to the later of three (3) years from the date of final payment or one (1) year following the final disposition of the dispute or litigation.
- (e) Subcontracts. The Contractor shall insert this article, in all subcontracts that exceed \$150,000.

9. AVAILABILITY OF FUNDS FOR THE NEXT FISCAL YEAR

Funds are not guaranteed for performance under this Contract beyond the current fiscal year that ends on June 30th. The Authority's obligation for performance of this Contract beyond that date is contingent upon the availability of funds from which payment for Contract purposes can be made. The Authority's legal liability for any payment cannot arise for performance under this Contract, until funds are made available to the Contracting Officer for performance and until he or she notifies the Contractor of the availability, in writing. Any option exercised by the Authority that will be performed, in whole or in part, in a subsequent fiscal year is subject to availability of funds in that year and will be governed by the terms of this article.

10. CONTRACTING OFFICER'S TECHNICAL REPRESENTATIVE (COTR)

- (a) The work will be conducted under the Contracting Officer's general directions. Authority will be delegated to the Contracting Officer's Technical Representative (COTR) to take the following actions;
- (1) Act as the principal point of contact with the Contractor. The COTR will submit a copy of each item of incoming correspondence and a copy of any enclosures to the Contract Administrator;
 - (2) Approve in writing, the Contractor's progress schedule and submittals when required;
 - (3) Inspect the work for compliance with this Contract;
 - (4) Review and approve invoices and payment estimates. The COTR will forward invoices and receipts to accounting. The COTR will bring any significant discrepancies in, or disputes concerning, Contractor invoices or payments to the Contracting Officer's attention. In those cases requiring release of final retained percentages of payment, the COTR will make his or her recommendations to the Contracting Officer in writing;
 - (5) Coordinate correspondence with the Contract Administrator, if its importance significantly impacts the Contractual terms and conditions;
 - (6) Evaluate the Contractor's technical letters and proposals for the Contracting Officer;
 - (7) Advise the Contracting Officer of potential problems that may affect Contract performance;
 - (8) Advise DBE Office, if DBE, SBE, or SBLPP issue(s) appear that may require investigation.
 - (9) Advise the Contracting Officer whenever the COTR has reason to believe that the Contractual not-to-exceed amount will be exceeded;
 - (10) Prepare the Authority's estimate for proposed Contract modifications. Participate in negotiations for modifications;
 - (11) Approve, in writing, the Contractor's progress schedule when required.
 - (12) Receive from the Contractor, monthly, if applicable, DBE status reports and forward them to the DBE Office;
 - (13) Receive from the Contractor certified payroll reports and prepare a log sheet indicating the following: (1) name of the Contractor and subcontractor; (2) the Contract number; (3) the certified payroll number (number for the payroll for the project starting with the number 1); (4) the time frame of the payroll period (i.e. 1/21/11-2/3/11); (5) the statement of compliance date (first page of the report); and (6) the date the report was received by WMATA;
 - (14) Maintain a comprehensive file/record of documents and correspondence concerning Contract activities and actions;
 - (15) Provide the Contract Administrator with a written notification after all supplies/services have been received with a statement that the COTR is not aware of any open issues that would preclude closeout of the Contract and that it is ready for closeout. The COTR will return the file, containing all records, correspondence, etc., to the Contract Administrator;
 - (16) Execute Standard Form 1420, which contains a detailed performance evaluation of the Contractor. If, there are one (1) or more categories in which the Contractor is deemed unsatisfactory, these evaluations must be provided to it for comment;
 - (17) Provide the Contract Administrator with a written request (and requisition) to exercise option(s) (if any) a minimum of ninety (90) days prior to the time established in this Contract for exercise of the option;

- (18) The presence or absence of the COTR or his or her inspectors shall not relieve the Contractor from any requirements of this Contract.
 - (19) The COTR may not re-delegate or sub-delegate his or her authority to act on the Contracting Officer's behalf. If, for whatever reason the COTR is unable or unwilling to fulfill his or her responsibilities under this Contract, only the Contracting Officer can designate a new COTR.
- (b) The COTR's name and address will be provided after award.

CHAPTER II – TIME/DELAYS/LIQUIDATED DAMAGES

1. PERIOD OF PERFORMANCE

The period of performance is 95 ___ days commencing on the date of Notice to Proceed. The Contractor shall comply with the following milestones:

Action	Dates
Deliver/Install Warehouse Racks	Mon 12/31/18 to Fri 1/11/19
Deliver/Install SIB Racks	Mon 1/14/19 to Fri 1/18/19
Deliver/Install MWB Racks	Mon 1/21/19

2. OPTIONS- EVALUATION

In awarding this Contract, the Contracting Officer shall evaluate offers for any option quantities or periods contained in a solicitation in accordance with PPM §§ 4-21 through 4-23.

3. OPTIONS- EXERCISE

- (a) When exercising an option, the Contracting Officer shall provide written notice to the Contractor within a reasonable amount of time before exercising the option.
- (b) When the Contract provides for economic price adjustment and the Contractor requests a revision of the price, the Contracting Officer shall determine the effect of the adjustment on prices under the option before the option is exercised.
- (c) In accordance with PPM § 4-23, the Contracting Officer may exercise options only after determining that—
 - (1) Funds are available;
 - (2) The requirement covered by the option fulfills an existing WMATA need;
 - (3) The exercise of the option is the most advantageous method of fulfilling WMATA's needs, when price and other factors are considered.
 - (4) Contractor is not listed in the System for Award Management's Exclusions (See www.sam.gov).
 - (5) The Contractor's past performance evaluations on other Contract actions have been considered; and
 - (6) The Contractor's performance on this Contract has been acceptable in that it received satisfactory ratings.
- (d) The Contracting Officer, after considering price and other factors, shall make the determination on the basis of one (1) of the following:
 - (1) A new solicitation fails to produce a better price or a more advantageous offer than that offered by the option. If it is anticipated that the best price available is the option price or that this is the more advantageous offer, the Contracting Officer should not use this method of testing the market.

- (2) An informal analysis of prices or an examination of the market indicates that the option price is better than prices available in the market or that the option is the more advantageous offer.
- (3) The time between the award of the Contract containing the option and the exercise of the option is so short that it indicates the option price is the lowest price obtainable or the more advantageous offer. The Contracting Officer shall take into consideration such factors as market stability and comparison of the time since award with the usual duration of Contracts for such supplies or services.
- (e) The determination of other factors under subparagraph (d):
 - (1) Should take into account WMATA's need for continuity of operations and potential costs of disrupting operations; and
 - (2) May consider the effect on DBEs.
- (f) Before exercising an option, the Contracting Officer shall make a written determination for the Contract file that the exercise is in accordance with the terms of the option, and the requirements of this clause. To satisfy requirements for full and open competition, the option must have been evaluated as part of the initial competition and be exercisable at an amount specified in or reasonably determinable from the terms of the basic contract, such as:
 - (1) A specific dollar amount;
 - (2) An amount to be determined by applying provisions (or a formula) provided in the basic contract, but not including renegotiation of the price for work in a fixed-price type contract;
 - (3) In the case of a cost-type contract, if—
 - (a) The option contains a fixed or maximum fee; or
 - (b) The fixed or maximum fee amount is determinable by *applying* a formula contained in the contract;
 - (4) A specific price that is subject to an economic price adjustment provision; or
 - (5) A specific price that is subject to change as the result of changes to prevailing labor rates provided by the U.S. Secretary of Labor.
- (g) The Contract modification or other written document that notifies the Contractor of the exercise of the option shall cite this article as authority.

4. OPTION FOR INCREASED OR DECREASED QUANTITIES OF SUPPLIES

WMATA may increase or decrease the quantities of supplies called for in the Price Schedule, at the unit price specified. WMATA may also require the delivery of a numbered line item, identified in the Price Schedule as an option item, in the quantity and at the price stated in the Price Schedule. The Contracting Officer may exercise the option by written notice to the Contractor within a reasonable amount of time before exercising the option. Delivery of the added items shall continue at the same rate as the like items called for under the Contract, unless the parties agree otherwise.

5. OPTIONS TO EXTEND SERVICES

WMATA may require continued performance of any services within the limits and at the rates specified in this Contract. These rates may be adjusted only as a result of revisions to the prevailing labor rates provided by the U.S. Secretary of Labor. This option provision may be exercised more than once, but the total extension of performance thereunder shall not exceed six (6) months. The Contracting Officer may exercise the option by written notice to the Contractor within a reasonable amount of time exercising the option.

6. OPTION TO EXTEND THE TERM OF THE CONTRACT

- (a) WMATA may extend the term of this Contract by written notice to the Contractor within a reasonable amount of time exercising the option, provided that WMATA gives the Contractor a preliminary notice of its intent to extend within a reasonable amount of time before the Contract expires. The preliminary notice does not commit WMATA to the extension.
- (b) If WMATA exercises this option, the extended Contract shall include this option clause.
- (c) The total duration of this Contract, including any options under this clause shall be reasonable as determined by the Contracting Officer in consultation with counsel (COUN).

7. OPTIONS EXERCISED OUT OF SEQUENCE

WMATA may exercise options at any time, including during the base period, and in any sequence, even if it varies from the sequence stated in the Price Schedule. The Contractor may be entitled to an equitable adjustment in the Contract price, if exercising the option out of sequence causes any undue delay in performance of this Contract. If options are extended during the base period or out of sequence, any previously agreed to economic price adjustment for exercise of the option may not apply, at the Contracting Officer's discretion.

8. LIQUIDATED DAMAGES FOR DELAY

Not Used

9. EXTENSIONS OF TIME/FORCE MAJEURE

- (a) For purposes of this clause, the term "force majeure" shall mean an unforeseen event or circumstance, beyond the control of, and not occasioned by the fault or negligence of, the Contractor or the Authority, that gives rise to a delay in the progress of the Contract, including, without limitation, acts of God, acts of war or insurrection, unusually severe weather, fires, floods, strikes, freight embargoes or other events or circumstances of like nature.
- (b) Notwithstanding the provisions of the "Liquidated Damages" article of this Contract (if applicable), if the Contractor is delayed at any time during the performance of this Contract, by the Authority's negligence or by a force majeure event, then the

Contracting Officer shall extend the time for completion and/or the affected delivery date(s) in the following circumstances:

- (1) The cause of the delay arises after the award of the Contract and neither was nor could have been anticipated by the Contractor by reasonable investigation before such award;
 - (2) The Contractor demonstrates to the Contracting Officer that the completion of the work and/or affected deliveries will be actually and necessarily delayed;
 - (3) The delay cannot be avoided or mitigated by the exercise of all reasonable precautions, efforts and measures available to the Contractor, whether before or after the cause of delay; and
 - (4) The Contractor makes a written request and provides other information to the Contracting Officer, as described below.
- (c) If the Contractor will be delayed at any time or for any period by two (2) or more of the above-mentioned causes, the Contractor shall not be entitled to a separate extension for each cause, but shall be entitled to only one (1) period of extension for the cumulative effects of the delay.
- (d) The Contracting Officer may rescind or shorten any extension previously granted, if he or she subsequently determines that any information that the Contractor provided in support of a request for an extension of time was erroneous, if, accurate information would have resulted in a denial of the request for an excusable delay. The Contracting Officer will not rescind or shorten any extension previously granted, if the Contractor acted in reliance upon it and if, in his or her judgment, such extension was based on information that the Contractor submitted in good faith, even if it is later determined to be erroneous.
- (e) The request for an extension of time shall be made within ten (10) days after the Contractor knows or should know of any cause for which it may claim an excusable delay. The Contractor's request shall contain any potential basis for an extension of time, describing, as fully as possible, the nature and projected duration of the delay and its effect on the completion of the work identified in the request. Within thirty (30) days after his or her receipt of all such information, the Contracting Officer shall advise the Contractor of his or her decision on such requested extension. Where it is not reasonably practicable for the Contracting Officer to render his or her decision in the thirty (30) day period, he or she shall, prior to the expiration of such period, advise the Contractor that he or she will require additional time and state the approximate date upon which he or she expects to render a decision.
- (f) In no event shall a delay in performance of the Contract occasioned solely by a force majeure event or the acts or omissions of any party outside of the Contractor's control be the basis for a termination for default pursuant to this Contract. In no event shall a subcontractor at any tier be deemed a party outside of the Contractor's control.

10. THE AUTHORITY'S DELAY

- (a) If the performance of all or any part of this Contract is delayed in a material manner or extent by the Authority's acts or omissions that are not expressly or impliedly authorized by this Contract or by applicable provisions of law, the Contracting Officer shall make an adjustment (excluding profit) for any increase in the cost of performance of this Contract caused by such delay and shall modify the Contract, in writing. The Contracting Officer shall make an adjustment to the delivery or performance dates and to any other Contractual provision, if such delay or interruption affected Contract compliance. The Contracting Officer shall make no adjustment under this Contract for any delay or interruption, if performance was or could have been delayed by any other cause, including, without limitation: (i) the fault or negligence of the Contractor or any subcontractor; (ii) an act constituting a force majeure event pursuant to this Contract; or (iii) any other cause for which an adjustment is provided under any other article of this Contract, at law or in equity.
- (b) An adjustment pursuant to paragraph (a) shall not be allowed:
 - (1) For any costs incurred more than twenty (20) days before the Contractor notifies the Contracting Officer, in writing, of the delay.
 - (2) Unless the claim, in a sum certain, is asserted in writing as soon as practicable after the termination of the delay. In no event, shall a Contractor assert a delay claim later than thirty (30) days after its termination. The delay claim shall be accompanied by appropriate documentation, specifically supporting the nature and extent of the claimed impact upon the cost and/or time required for performance. In any instance where it is not possible for the Contractor to fully project such impact within the thirty (30) day period, it shall support the claim with such documentation as is then reasonably available, along with a statement of the anticipated time frame when the Contractor expects to provide the additional materials. The Contracting Officer shall maintain the right throughout the process to request such additional materials as he or she shall reasonably require in consideration of the claim and shall be under no obligation to conclude his or her consideration of the claim prior to review of all relevant materials. Any adjustment to the Contract price pursuant to this article must be determined prior to final payment under this Contract.

11. NOTICE TO THE AUTHORITY OF LABOR DISPUTES

- (a) Whenever the Contractor has knowledge that any actual or potential labor dispute is delaying or threatens to delay the timely performance of this Contract, the Contractor shall immediately give notice thereof, including all relevant information with respect thereto, to the Contracting Officer.
- (b) The Contractor agrees to insert the substance of this article, including this paragraph (b), in any subcontract hereunder if a labor dispute may delay the timely performance of this Contract.

12. NOTIFICATION OF BANKRUPTCY OR INSOLVENCY

In the event the Contractor becomes insolvent or files or has filed against it a petition in bankruptcy, whether voluntary or involuntary, the Contractor agrees to furnish, by certified

mail or electronic commerce method authorized by the Contract, written notification of such to the Contracting Officer. This notification shall be furnished as soon as possible, but in no event more than ten (10) days of the initiation of the proceedings relating to bankruptcy filing. This notification shall include the date on which the bankruptcy petition was filed, the identity of the court in which the bankruptcy petition was filed, and a listing of all WMATA Contract numbers for all WMATA contracts against which final payment has not been made. This obligation remains in effect until final payment under this Contract.

CHAPTER III – ACCEPTANCE/INSPECTIONS/DEFICIENCIES

1. INSPECTION OF SERVICES

- (a) The Contractor shall provide and maintain an inspection system acceptable to the Authority covering the services under this Contract. The Contractor shall maintain complete records of all inspection work it performs and make them available to the Authority during Contract performance in the manner and in accordance with the time periods set forth in the “Audit and Inspection of Records” article of this Contract.
- (b) The Authority has the right to inspect and test all services called for by this Contract, at all times and places reasonably practicable during the term of this Contract. The Authority shall perform inspection and tests in a manner that will not unduly delay the Contract.
- (c) If the Authority performs inspections or tests on the Contractor’s or subcontractor’s premises, the Contractor shall furnish, and shall require subcontractors to furnish, without cost, all reasonable facilities and assistance for the safe and convenient performance of such inspections or tests.
- (d) If any of the services performed do not conform to the Contract’s requirements, the Authority may require the Contractor to perform them again in conformity with the Contract’s requirements, without additional cost. When the defects in performance cannot reasonably be corrected by such further performance, the Authority may:
 - (1) Direct the Contractor to take necessary action to ensure that future performance conforms to this Contract’s requirements; and/or
 - (2) Reduce the Contract price to reflect the reduced value of the services performed.
- (e) If the Contractor fails to comply with the provisions of paragraph (d), the Authority may:
 - (1) By contract or otherwise, perform the services and charge to the Contractor any cost thereby incurred by the Authority; and/ or
 - (2) In the event that the Contracting Officer deems such failure to comply a material breach, terminate the Contract for default.
- (f) Nothing contained herein shall be deemed to preclude the Contracting Officer from reducing the Contract price due to the reduced value of nonconforming services to the Authority.

2. INSPECTION OF SUPPLIES

- (a) The Contractor shall provide and maintain an inspection system acceptable to the Authority covering supplies under this Contract and shall tender to the Authority for acceptance only supplies that have been inspected in accordance with the inspection system and that the Contractor determines to be in conformity with this Contract’s requirements. As part of the system, the Contractor shall prepare records evidencing

the nature and result of all inspections. These records shall be made available to the Authority during the term of the Contract and thereafter in accordance with the "Audit and Inspection of Records" article of this Contract. The Authority may perform reviews and evaluations as reasonably necessary to ascertain compliance with this article. These reviews and evaluations shall be conducted in a manner that will not unduly delay the Contract. Reviews, whether exercised or not, do not relieve the Contractor of its obligations under this Contract.

- (b) The Authority has the right to inspect and test all supplies under this Contract, to the extent practicable, at all places and times, including during manufacturing, and before acceptance. The Authority shall perform inspections and tests in a manner that will not unduly delay the Contract. The Authority assumes no Contractual obligation to perform any inspection and/or test nor shall the Authority's failure to perform any inspection and/ or test relieve the Contractor of any obligation under this Contract.
- (c) If the Authority performs inspection(s) or test(s) on the Contractor's or subcontractor's premises, the Contractor shall furnish, and shall require subcontractors to furnish, without additional cost, all reasonable facilities and assistance for the safe and convenient performance of these inspections or tests.
- (d) When supplies are not ready at the time specified for inspection or testing, the Contracting Officer may charge to the Contractor for any additional associated costs. The Contracting Officer may also charge the Contractor for any additional costs of inspection or testing when prior rejection makes re-inspection or retesting necessary.

3. ACCEPTANCE OF SUPPLIES

- (a) The Authority shall accept or reject tendered supplies as promptly as practicable after delivery, unless otherwise provided in this Contract. The Authority's failure to inspect and/or accept or reject the supplies shall not relieve the Contractor from responsibility, nor impose liability upon the Authority, for nonconforming supplies.
- (b) The Authority's acceptance shall be deemed conclusive, except for latent defects, fraud, willful misconduct, gross mistakes amounting to fraud or as otherwise provided in this Contract. In such instances, the Authority, in addition to any other rights and remedies it has under this Contract, at law or in equity, shall have the right:
 - (1) To direct the Contractor, at no increase in Contract price, to correct or replace the defective or nonconforming supplies at the original point of delivery or, if the Contracting Officer determines, at the Contractor's facility, in accordance with a reasonable delivery schedule as may be agreed upon between the parties. The Contracting Officer may reduce the Contract price, if the Contractor fails to meet such delivery schedule; or
 - (2) Within a reasonable time after the Contractor's receipt of a Notice of Defects or Nonconformance, the Contracting Officer may reduce the Contract price, as is equitable under the circumstances, if he or she elects not to require correction or replacement. When supplies are returned to the Contractor, the Contractor shall bear the costs of transportation.

4. NEW MATERIAL [SUPPLIES]

Unless this Contract specifies otherwise, the Contractor represents that any supplies and components to be provided under this Contract are new (not used or reconditioned, and not of such age or so deteriorated as to impair their usefulness or safety). If at any time during the performance of this Contract, the Contractor believes that furnishing supplies or components that are not new is in the Authority's best interests, the Contractor shall notify the Contracting Officer immediately in writing. The Contractor's notice shall include the reasons for the request, along with any proposed price reduction, that the Authority may take if the Contracting Officer agrees to authorize such supplies or components. The Contracting Officer's authorization to use such supplies or components shall be final and binding and not subject to further review pursuant to the "Disputes" article of this Contract or otherwise.

5. WARRANTY OF SUPPLIES

- (a) All workmanship, parts and materials furnished for this Contract shall be unconditionally warranted against failures or defects for a period of one (1) year after the Authority accepts them or places them in service, whichever is earlier. The Contractor shall accept the Authority's records regarding the date the item was placed in service.
- (b) In the event that any work covered by the warranty provisions fails during the warranty period, the Contractor shall repair or replace the work within three (3) days without cost or expense to the Authority.
- (c) Should the Contractor shall fail to repair or replace any part or do any work in accordance with the terms of this warranty, or if immediate replacement or work is necessary to maintain operations, the Authority shall have the right to cause such replacement to be made, utilizing its own forces and/or those of third parties as the Authority shall reasonably deem appropriate, at the Contractor's expense.
- (d) Each piece of equipment, component or part thereof that the Contractor replaces, repairs, adjusts or services in any manner under the terms of this warranty during the warranty period shall be reported to the Contracting Officer on the Authority's forms. Each report shall indicate in detail all repairs, adjustments and servicing to each and every component, unit or part thereof.
- (e) Any warranty work shall be accomplished with minimum disruption to the Authority's operations and to its maintenance and service facilities. The Authority shall at its sole discretion determine the availability of facilities for warranty work.
- (f) The Contractor shall make adequate service facilities available, along with spare parts, for all the items under warranty. Trained technical service personnel shall be available to the Authority sufficient to meet the Contractor's warranty obligations.
 - (1) The Contractor shall provide field service representatives who are competent and fully qualified in the maintenance and operation of the warranted items. These field service representatives shall assist the Authority in overcoming any difficulties in the operation or maintenance of the warranted items. They shall further serve as the Contractor's on-site representatives for any component failure claims or warranty claims under this Contract.

- (2) During the warranty period, a field service representative shall be available within twenty four (24) hours.
- (g) The Authority's rights set forth in this article shall be in addition to those set forth elsewhere in this Contract or otherwise at law or in equity.

6. WARRANTY OF SERVICES

- (a) Definitions.

“Acceptance,” as used in this clause, means the act(s) of WMATA’s authorized representative by which WMATA approves specific services, in partial or complete performance of the Contract.
- (b) Notwithstanding inspection and acceptance by WMATA or any provision concerning the conclusiveness thereof, the Contractor warrants that all services performed under this contract will, at the time of acceptance, be free from defects in workmanship and conform to the requirements of this contract. The Contracting Officer shall give written notice of any defect or nonconformance to the Contractor within thirty (30) days from the date of acceptance by WMATA. This notice shall state either --
 - (1) That the Contractor shall correct or re-perform any defective or nonconforming services; or
 - (2) That WMATA does not require correction or re-performance.
- (c) If the Contractor is required to correct or re-perform, it shall be at no cost to WMATA, and any services corrected or re-performed by the Contractor shall be subject to this clause to the same extent as work initially performed. If the Contractor fails or refuses to correct or re-perform, the Contracting Officer may, by contract or otherwise, correct or replace the services with similar services and charge the Contractor with the cost, or make an equitable adjustment to the Contract price.
- (d) If WMATA does not require correction or re-performance, the Contracting Officer shall make an equitable adjustment to the Contract price.

7. CORRECTION OF DEFICIENCIES

- (a) The Contractor must replace materials or correct workmanship not conforming to the Contract’s requirements at no additional cost to WMATA. In addition, the Contractor is subject to any liquidated damages specified in this Contract or actual damages incurred by WMATA. If the Contractor fails to correct deficiencies, the Contracting Officer, may take specific action as follows:
 - (1) Replace or correct the item or work at the Contractor’s expense. This may be accomplished by award of a new contract or by use of WMATA’s own resources.
 - (2) Accept the items with a reduction in price. This action will be accomplished by formal modification to this Contract. The reduced price will be based upon

the reasonable value of the item, considering the possible cost of correcting the item.

- (3) Terminate this Contract for default. If the item or work must be re-procured, the Contractor is normally liable for excess costs incurred by WMATA in accordance with the "Termination for Default" article of this Contract.

8. FIRST ARTICLE INSPECTION

Not Applicable

9. F.O.B. DESTINATION

- (a) Unless otherwise specified, the Contractor shall furnish all supplies to be delivered under this Contract "F.O.B. Destination". As used herein, "F.O.B. Destination" means:
- (1) Free of expense to WMATA on board the carrier's conveyance, at a specified delivery point where WMATA's facility (plant, warehouse, store, lot, or other location to which shipment can be made) is located; and
 - (2) Supplies shall be delivered to WMATA's warehouse unloading platform, or receiving dock, at the Contractor's expense. WMATA shall not be liable for any delivery, storage, demurrage, accessorial, or other charges involved before the actual delivery of the supplies to the destination, unless such charges are caused by WMATA's acts or omissions, acting in its Contractual capacity. If the Contractor uses a rail carrier or freight forwarder for less than full carload shipments, the Contractor shall assure that the carrier will furnish tailgate delivery, if transfer to truck is required to complete delivery to WMATA.
- (b) The Contractor shall:
- (1) Pack and mark the shipment to comply with this Contract's specifications;
 - (2) In the absence of specifications, prepare the shipment in conformance with carrier requirements;
 - (3) Prepare and distribute commercial bills of lading;
 - (4) Deliver the shipment in good order and condition to the delivery point specified in the Contract;
 - (5) Be responsible for any loss of and/or damage to the goods occurring before receipt of the shipment by WMATA at the delivery point specified in the Contract;
 - (6) Furnish a delivery schedule and designate the mode of delivering carrier; and
 - (7) Pay and bear all charges to the specified point of delivery.

10. QUALITY ASSURANCE/QUALITY CONTROL

The Contractor shall be responsible for quality assurance and for assuring that the work conforms to the requirements of this Contract. The Contractor shall maintain an effective and economical quality control program planned and developed in conjunction with other Contractor functions necessary to satisfy this Contract's requirements. The quality control program shall establish and implement procedures to ensure that only acceptable supplies or services are tendered to the Authority for acceptance, and shall demonstrate both

recognition of the Contract's quality requirements and an organized approach to satisfying them. The program shall ensure that quality requirements are satisfied throughout all phases of Contract performance, including, as applicable, design development, purchasing, fabrication, processing, assembly, inspection, testing, packaging, delivery, and storage and shall provide for the early detection of actual or potential deficiencies, trends, or conditions that could result in unsatisfactory quality.

CHAPTER IV—CHANGES/ PRICING ADJUSTMENTS

1. CHANGE ORDERS

- (a) The Contracting Officer may at any time, by a written order, and without notice to the sureties, if any, direct and implement change orders, within the general scope of this Contract, including but not limited to one or more of the following:
 - (1) Nature and/or extent of services to be performed or supplies to be furnished;
 - (2) Time of performance (i.e., hours of the day, days of the week, etc.); or
 - (3) Place of performance of the services or delivery of the supplies.
- (b) If, in the Contracting Officer's judgment, any change causes an increase or decrease in the cost of, or the time required for, the performance of any part of this Contract, whether or not directly changed by the order, he or she shall make an equitable adjustment to the Contract price, the delivery schedule, or both, and shall modify the Contract, in writing, accordingly.
- (c) In any instance where the Contractor asserts a right to an adjustment in the Contract price or time required for performance as the result of a change, it must submit a written claim advising the Authority within thirty (30) days from the date of receipt of the written order directing the change. The claim shall be accompanied by appropriate documentation, supporting the nature and extent of the claimed impact upon the Contract price and/or time required for performance. In any instance where it is not reasonably practicable fully project such impact within the thirty (30) day period, the Contractor shall accompany its claim with such supporting documentation as is then reasonably available as along with a statement of the anticipated time frame when the Contractor expects to provide the additional materials. The Contracting Officer shall maintain the right throughout the process to request such additional materials as he or she shall reasonably require in consideration of the claim and shall be under no obligation to conclude his or her consideration of the claim prior to review of all relevant materials. Any adjustment to the Contract price pursuant to this article must be agreed upon or otherwise determined prior to final payment.
- (d) If the Contractor's proposed price adjustment includes the cost of property rendered obsolete or excess by the change, the Contracting Officer shall have the right to prescribe the manner of property disposition.
- (e) Disagreement regarding either party's right to any adjustment in price or time for performance as the result of a change implemented pursuant to this article shall be subject to adjudication in accordance with the "Disputes" article of this Contract. Notwithstanding the pendency of any such dispute, the Contractor expressly acknowledges that it shall remain fully obligated to perform the Contract as so changed.
- (f) The Contractor shall promptly notify the Contracting Officer of matters, whether implemented as change orders or otherwise, that the Contractor believes may reasonably result in either an increase or decrease in the Contract price or the time

required for performance of any part of the Contract and shall take action as the Contracting Officer directs. The Contractor's failure to provide such notification shall constitute a waiver of its right to seek an adjustment in the Contract price or time required for such performance.

- (g) In no event shall the Contractor be entitled to payment for change orders, additional or extra supplies or services or other modifications to this Contract, unless the Contracting Officer authorizes, it in writing.

2. PRICING OF ADJUSTMENTS

- (a) The parties agree that, notwithstanding any interpretation of contract cost principles to the contrary, the Authority will not be liable for interest, however represented, on or as a part of any claim, request, proposal or adjustment, including equitable adjustments, whether it arises under the Contract or otherwise.
- (b) As part of its proposal for any Contract modification requiring a price adjustment in excess of \$150,000, the Contractor shall submit to the Contracting Officer, cost or pricing data under the conditions described in this paragraph and certify that, to the best of its knowledge and belief, the cost or pricing data submitted is accurate, complete and current as of the date submitted. At the Contracting Officer's discretion, the Contractor, may be required to submit cost or pricing data for price adjustments less than \$150,000.
- (c) The Contractor shall ensure that this article is included in all subcontracts at any tier, if the value of the subcontracted work exceeds \$150,000.

3. ACCOUNTING AND RECORD KEEPING FOR ADJUSTMENTS

- (a) *Applicability.* This article shall apply to any adjustment in the Contract price initiated by the Contractor or the Authority.
- (b) *Forward Price Adjustments.* Unless waived in writing, the Contractor shall furnish to the Contracting Officer, a proposed price adjustment in advance of performance of any work for which the price adjustment is requested. The Contractor shall generate such records as are necessary to substantiate all elements of the proposed adjustment, which records shall be specifically segregated and identified in the Contractor's accounting system as being applicable to the pricing adjustment request.
- (c) *Post Price Adjustments.* This paragraph shall be applicable to price adjustments that either (i) are expected to exceed \$50,000; or (ii) arise in connection with a Contract with a base sum in excess of \$1,000,000. In addition to the records required pursuant to paragraph (b) above, if pricing of an adjustment under this Contract is not agreed upon between the parties prior to the commencement of work for which the pricing adjustment is requested, the Contractor and any subcontractor engaged in work for which the pricing adjustment is requested, shall maintain accounts and original cost records specifically segregated and identified by job order or other appropriate accounting categories that the Contracting Officer approves for all incurred, segregable costs related to the work for which the pricing adjustment is requested. The Contractor shall maintain accounts and records that segregate and account for the costs of all work associated with that part of the Contract for which

the pricing adjustment is requested. The Contractor shall allocate the costs so accumulated between: (1) work required under the base Contract; (2) work requested to be reimbursed under the pricing adjustment; and (3) work claimed or determined to be related to other actual or proposed adjustments, including but not limited to, changes orders, differing site conditions, and the like. The accounts and records so established shall accumulate such costs under logical costs groups, such as material, labor, equipment, subcontracts, field overhead and the like. The Contractor shall record these costs on a form approved by the Contracting Officer.

- (e) *Access to Records.* As a condition to the Authority's obligation to consider any claim for a potential price adjustment under any provision of this Contract, the Contractor shall grant the Authority access to review and ascertain the validity of the accounting records being maintained for segregation of costs, including base cost records, and to audit any such costs as the Contracting Officer deems appropriate.

- (f) *Limitation on Price Adjustments.* If the Contractor or any subcontractor fails to generate, maintain, or make available any records required under this Contract, in addition to any rights to which the Authority may be entitled, the Contracting Officer shall determine whether such failure is willful, deliberate or otherwise precipitated by the Contractor's bad faith, in which case the Contractor shall not be entitled to any price adjustment for the work in question. Where the Contracting Officer determines that the failure was not the result of the Contractor's bad faith, he or she shall determine the reasonable direct costs of the work for which records are not available, and add a single mark-up for indirect expenses not to exceed ten percent (10%) of the direct costs based on:
 - (1) An audit of the Contractor's or subcontractor's records made available to the Authority; and/or
 - (2) The Authority's estimate as the Contracting Officer adopts or modifies

- (g) In no event shall the Contractor and/or subcontractor be allowed any profit on claimed work for which records are not made available in accordance with its obligations under this Contract.

- (h) *Flow-down clause.* The Contractor shall ensure the inclusion of this article in all subcontracts issued under this Contract, modified as necessary, for proper identification of the contracting parties and the Contracting Officer.

CHAPTER V – INVOICES/PAYMENTS/ DEDUCTIONS

1. BILLING AND PAYMENT

- (a) The Authority shall pay and the Contractor shall accept the amounts set forth in the Price Schedule as full compensation for all costs and expenses of completing the this Contract, including, but not limited to, all labor and material required to be furnished under this Contract, all overhead, expenses, fees and profits including the cost of providing storage yards or facilities; all risks and obligations set forth in this Contract; any applicable fees or taxes; and all expenses due to any unforeseen difficulties encountered in the prosecution of the work.
- (b) Payments will be made following acceptance of the services or supplies to be provided under this Contract and after receipt and acceptance of a properly completed invoice. WMATA will accept the submittal of invoices in one of the following methods:
- (1) Email: Invoices may be submitted through email at: apinvoice@wmata.com. Please submit one (1) invoice and supporting documentation per PDF attachment. You may submit more than one PDF attachment per email.
- (2) Fax: Invoices may be submitted via the following number: 1-866-534-9063. Please submit one (1) invoice and all supporting documentation for this invoice per fax.
- (3) Regular Mail: Invoices may be submitted via U.S. Postal Service to the following address:
- WMATA-Accounts Payable
PO Box 1910
Beltsville, MD 20704-1910
- Note: This address is only for vendor invoices. Correspondence should not be sent to this address.
- (c) Invoices shall contain the vendor's name, a unique invoice number for each shipment or service, invoice date, payment terms, total invoice amount, "remit to" address, purchase order number, freight terms, description of each item being invoiced, quantity, unit item cost, extended cost by item, total freight/handling costs, and contact name and email address. Final invoices must clearly be marked "Final" and cite the amount of this Contract, amount previously paid, and the balance due.
- (d) The Authority shall remit payment, generally within thirty (30) days of its receipt and acceptance of an invoice satisfying the requirements of paragraphs (b) and (c), at the prices stipulated in the Contract for supplies delivered and accepted or services rendered and accepted, less any applicable deductions.

2. PRICE REDUCTION FOR DEFECTIVE COST OR PRICING DATA – MODIFICATIONS

If the Contracting Officer determines that any price, including profit or fee, previously negotiated in connection with any modification to this Contract involving changes in cost plus

applicable profit in excess of \$150,000 was based upon the Contractor's or subcontractor's cost or pricing data that was not complete, accurate or current, such that the amount the Authority paid to the Contractor for such price adjustment was greater than the Contractor would have been entitled to, based upon accurate and complete data, the Authority shall be entitled to an adjustment in an amount equal to such overpayment. The Authority's rights hereunder shall be in addition to any other rights it may have under this Contract, at law or in equity.

3. SUBCONTRACTOR PAYMENTS

- (a) The Contractor shall, under this Contract, establish procedures to ensure timely payment of amounts due pursuant to the terms of its subcontracts. The Contractor shall pay each subcontractor for satisfactory performance of its contract, or any billable portion thereof, no later than ten (10) days from the date of the Contractor's receipt of payment from the Authority for work by that subcontractor. The Contractor shall also release, any retention withheld from the subcontractor within ten (10) days of satisfactory completion of all work required by that subcontractor.
- (b) The Contractor shall certify on each payment request to the Authority that payment has been or will be made to all subcontractors in accordance with paragraph (a) above. The Contractor shall notify the Contracting Officer with each payment request, of any situation where scheduled subcontractor payments have not been made.
- (c) In the event of a claim by any subcontractor that the Contractor has failed to comply with the terms of this article, the Contractor agrees to fully cooperate in any Authority investigation, and, if deemed appropriate by the Authority, to implement appropriate remedial measures to ensure future compliance.
- (d) The Contractor agrees that the Contracting Officer may provide information that he or she deems appropriate in response to inquiries from subcontractors seeking to determine the status of the Authority's payments to the Contractor.
- (e) Nothing contained in this article or elsewhere in this Contract shall create a Contractual relationship between the Authority and any subcontractor, shall make the subcontractor an intended beneficiary of this Contract or shall alter or affect traditional concepts of privity of contract.

4. GARNISHMENT OF PAYMENTS

Payments under this Contract shall be subject to any garnishment, attachment orders, and/or levies issued pursuant to the laws of the United States, Maryland, Virginia, and the District of Columbia.

CHAPTER VI – CONTRACT TERMINATION/STOP WORK ORDERS/DISPUTES

1. STOP WORK ORDERS

- (a) The Contracting Officer may, at any time, by written order to the Contractor, require the Contractor to stop all, or any part of the work for a period of up to ninety (90) days after the order is delivered to the Contractor, and for any further period to which the parties may agree. The order shall be specifically identified as a “Stop Work Order” (“SWO”) issued under this article. Upon receipt of the SWO, the Contractor shall immediately comply with its terms and take all reasonable steps to minimize the incurrence of costs allocable to the work covered by the SWO during the period of work stoppage. Within a period of ninety (90) days after an SWO is delivered to the Contractor, or within any extension of that period to which the parties agree, the Contracting Officer shall either:
 - (1) Cancel the SWO; or
 - (2) Terminate the work covered by the SWO as provided in this Contract, as appropriate.
- (b) If a SWO is cancelled or expires, the Contractor shall resume work. The Contracting Officer shall make an equitable adjustment to the delivery schedule or Contract price, or both, and shall modify the Contract in writing if, in his or her judgment:
 - (1) The SWO results in an increase in the time required for, or in the Contractor's cost properly allocable to, the performance of any part of this Contract; and
 - (2) The Contractor submits a written claim for such adjustment within thirty (30) days after the end of the period of work stoppage. At the Contracting Officer's discretion, the Authority may act upon any claim submitted at any time before final payment under this Contract.
- (c) If an SWO is not cancelled and the work covered by the Contract is terminated for the convenience of the Authority, the Contracting Officer shall allow reasonable costs, if any, resulting from the SWO in arriving at the termination settlement pursuant this Contract.

2. TERMINATION FOR DEFAULT- FTA

- (a) The Contractor shall be in default if it commits a breach of any of its obligations under this Contract deemed material by the Contracting Officer. In addition to those instances specifically referred to in this Contract, the Contractor shall be in default in the following circumstances:
 - (1) It fails to begin, or abandons, the work of the Contract in accordance with the contractual requirements;
 - (2) It fails to deliver the supplies or perform the services within the time specified in this Contract or any extension that the Contracting Officer approves;

- (3) It fails to make progress in a manner that the Contracting Officer deems unreasonable so as to endanger performance of this Contract; or
 - (4) In the view of the Contracting Officer, the Contractor is willfully violating this Contract or is not executing it reasonably and in good faith.
- (b) In the event the Contractor's material breach pursuant to paragraph (a), the Contracting Officer is authorized to direct a written notice (a "Notice to Cure") to the Contractor, specifying the nature of the breach and stating that the Contractor has ten (10) days to cure the breach or such additional time as the Contracting Officer authorizes. If the Contractor fails to cure the breach in the time specified in the Notice to Cure, the Contracting Officer may terminate this Contract, in whole or designated part, for default after providing written notice to the Contractor.
- (c) Upon receipt of a "Notice of Default," the Contractor shall immediately cease performance of the work so terminated. The Authority shall have the right to take any action necessary to complete the work, including performing the work itself, or contracting with another party to do so. In the event the work is completed directly by the Authority or by a third party, the Contractor shall be liable for the additional costs and expenses necessary to complete the work, including, without limitation, labor, material costs, plant costs, tooling expenses, and equipment and property costs. The Authority may deduct the costs and expenses so charged and pay them out of any monies otherwise payable to the Contractor. Nothing contained herein shall be deemed to relieve the Contractor of its continuing obligation to perform any portion of this Contract that was not terminated.
- (d) The Contracting Officer may, at his or her sole discretion, waive a default by the Contractor, but such waiver shall not be deemed a waiver of any subsequent default.
- (e) Upon any termination for default, the Contracting Officer may require the Contractor to transfer title and deliver to the Authority, any completed or partially completed supplies, components (including data and intellectual property) and Contract rights that the Contractor has specifically produced or acquired for the terminated portion of this Contract. At the Contracting Officer's direction, the Contractor shall also protect and preserve property in its possession in which the Authority may have an interest.
- (f) Upon any termination for default, the Authority shall pay for supplies delivered and accepted and/or services rendered and accepted in accordance with the terms of this Contract. The Authority may also compensate the Contractor for actions that it reasonably takes at the Contracting Officer's direction for the protection and preservation of property. The Authority may withhold from these payments any sum that the Contracting Officer determines to be necessary to protect the Authority against loss because of outstanding or claimed liens, or pending or anticipated claims under the Contract.
- (g) If, at any time following the Authority's issuance of a termination for default hereunder, it is determined that the Contractor was not in default or that the default was excusable, the termination shall be converted to a termination for convenience and the rights and obligations of the parties shall be determined in accordance with the "Termination for Convenience" article of this Contract.
- (h) Any dispute or disagreement regarding any issue arising under this article shall be subject to adjudication in accordance with the "Disputes" article of this Contract. In

no event shall the Authority's issuance of a "Notice to Cure" pursuant to paragraph (b) be the basis of a dispute pursuant to the "Disputes" article or otherwise be subject to further review under this Contract or otherwise. The pendency of any dispute shall not constitute a basis for the delay or suspension of, or otherwise affect the Authority's right to proceed in accordance with this article, including without limitation, its right to complete the work or its right to insist that the Contractor complete any portion of the Contract that was not terminated.

- (i) The Authority's rights and remedies in this article are in addition to any other rights and remedies provided under this Contract, at law or in equity.

3. TERMINATION FOR CONVENIENCE- FTA

- (a) The Contracting Officer may terminate this Contract in whole, or in part, if he or she determines that a termination is in the Authority's interest. The Contracting Officer shall terminate by delivering a "Notice of Termination" to the Contractor specifying the extent of termination and its effective date.
- (b) Upon receipt of a Notice of Termination, except as the Contracting Officer otherwise directs, the Contractor shall immediately:
 - (1) Stop work as specified in the Notice of Termination;
 - (2) Complete performance of the work not terminated;
 - (3) Place no further subcontracts or orders for materials, services, or facilities, except as necessary to complete the remaining portion of the Contract;
 - (4) Terminate all subcontracts to the extent that they relate to the work terminated;
 - (5) Assign to the Authority, as directed by the Contracting Officer, all of the Contractor's right(s), title, and interest(s) under the subcontracts terminated. The Authority shall have the right to settle or pay any termination costs arising out of the subcontracts and have no further liability to the Contractor for the work that was the subject of such subcontracts;
 - (6) With the Contracting Officer's approval, settle all outstanding liabilities and settlement costs arising from the termination of subcontracts;
 - (7) As the Contracting Officer directs, transfer title and deliver to the Authority:
 - (i) Parts, work in process, completed work, supplies, and other material produced or acquired for the work terminated; and
 - (ii) The completed or partially completed plans, drawings, information and other property that would have been required to be furnished to the Authority, if the Contract had been completed.
 - (8) Take any action that may be necessary, or as the Contracting Officer may direct, for the protection and preservation of the property related to this

Contract that is in the Contractor's possession and in which the Authority has or may acquire an interest;

- (9) Use its best efforts to sell, as the Contracting Officer authorizes, any property of the types referred to in paragraph (b)(7). The Contractor is not required to extend credit to any purchaser and may acquire the property under the conditions that the Contracting Officer prescribes. The proceeds of any transfer or disposition will be applied to reduce payments to be made by the Authority under this Contract, credited to the price or cost of the work, or paid in any other manner that the Contracting Officer directs.

- (c) The Contractor shall submit complete termination inventory schedules not later than one hundred twenty (120) days from the effective date of termination, unless the Contracting Officer extends the time in writing.

- (d) As soon as reasonably practicable, and not later than twenty (20) business days following the Authority's issuance of a "Notice of Termination" pursuant to paragraph (a), the Contractor shall submit a termination settlement proposal (TSP) to the Contracting Officer in the form that he or she prescribes, detailing the costs to which it asserts entitlement pursuant to this article. If the Contractor fails to submit the TSP within the time prescribed, the Contracting Officer may determine, on the basis of information available, the amount, if any, due to the Contractor as a result of the termination and shall pay the amount so determined.

- (e) Following submission of the Contractor's TSP pursuant to paragraph (d), the parties shall agree upon the whole, or any part, of the amount to be paid or remaining to be paid as a result of the termination. The amount may include a reasonable allowance for profit on work completed. In no event shall the total amount to be paid to the Contractor pursuant to this article exceed the total Contract price as reduced by (1) payments previously made and (2) the Contract price of the remaining work, not terminated.

- (f) If the parties disagree on the whole amount to be paid because of the termination, the Contracting Officer shall pay the Contractor the amounts that he or she determines as follows, but without duplication of any amounts agreed upon under paragraph (e):
 - (1) The Contract price for completed supplies or services that the Authority accepted [or sold or acquired under paragraph (b)(9)] not previously paid for, adjusted for any saving of freight and other charges.

 - (2) The total of:
 - (i) The costs incurred prior to termination in the performance of the work terminated, including initial costs and preparatory expenses allocable thereto, but excluding any costs attributable to items compensated or to be paid for under subparagraph (f)(1);

 - (ii) Termination costs under terminated subcontracts that are properly chargeable to the terminated portion of this Contract, if not excluded in subparagraph (f)(2)(i); and

- (iii) A sum, representing profit on the items described in subparagraph (f)(2)(i) that the Contracting Officer determines to be fair and reasonable pursuant to Section 49.202 of the Federal Acquisition Regulation (FAR), in effect on the date of this Contract. If it appears that the Contractor would have sustained a loss on the entire Contract had it been completed, the Contracting Officer shall allow no profit under this subparagraph and shall reduce the settlement to reflect the projected rate of loss.
- (3) The reasonable indirect costs of settlement of the work terminated, including:
 - (i) Accounting, legal, clerical, and other expenses reasonably necessary for the preparation of TSP(s);
 - (ii) The termination and settlement of subcontracts (excluding the amounts of such settlements); and
 - (iii) Storage, transportation, and other costs incurred, reasonably necessary for the preservation, protection, or disposition of the termination inventory.
- (g) Except for normal spoilage, and except to the extent that the Authority expressly assumed the risk of loss, the Contracting Officer shall exclude from the amounts payable to the Contractor under paragraph (f), the fair value, as he or she determines of property that is unavailable or damaged and undeliverable to the Authority or to a third party.
- (h) The cost principles and procedures of FAR Part 31 in effect on the date of this Contract, shall govern all costs claimed, agreed to, or determined under this article, except that the Authority shall not be obligated to pay interest, however represented, on any claimed costs.
- (i) The Contractor shall have the right to appeal, under the "Disputes" article, from the Contracting Officer's determination under paragraphs (d) or (f). The Contractor's failure to submit the TSP within the time provided in paragraph (d), or to timely request an extension thereof, shall constitute a waiver of its right to appeal the Contracting Officer's determination pursuant to the "Disputes" article or any otherwise applicable Contractual, legal or equitable remedy.
- (j) In determining any sum due to the Contractor under this article, there shall be deducted:
 - (1) All unliquidated advances or other payments to the Contractor under the terminated portion of this Contract;
 - (2) The value, as the Contracting Officer, reasonably determines, of any claim that the Authority has against the Contractor under this Contract, including any third-party claim, if the Contracting Officer is not satisfied that sufficient insurance coverage is in place; and

- (3) The agreed price for, or the proceeds of sale of, materials, supplies, or other items that the Contractor procured or sold under this article, not recovered by or credited to the Authority.

- (k) If the Contractor asserts that any partial termination has rendered enforcement of the remainder of this Contract at the remaining Contract price inequitable, the Contractor may file a proposal with the Contracting Officer for an adjustment to the price(s) for the continued portion of this Contract. Such proposal shall be submitted within ninety (90) days from the effective date of termination, unless the Contracting Officer extends it in writing, and shall be accompanied by appropriate supporting documentation.

- (l) The Contractor's responsibilities and obligations under this article shall remain in full force and effect notwithstanding the pendency of any dispute or other delay relating to determination of the appropriate price adjustment or any other issue arising from the termination for convenience.

- (m) Unless otherwise provided in this Contract or by statute, the Contractor and all subcontractors whose work is encompassed in the termination settlement shall maintain all records and documents relating to the terminated portion of this Contract for three (3) years after final settlement. This includes all books and other evidence bearing on the Contractor's costs and expenses under this Contract. The Contractor shall make these records and documents available to the Authority, its governing jurisdictions and any other Federal, state, or local entities providing funding for this Contract, and to the U.S. Comptroller General or the agents or representatives of any of them, at the Contractor's office, at all reasonable times, without any direct charge.

4. ASSIGNMENT- FTA

- (a) Except as otherwise provided in this article, the Contractor shall not transfer any of its rights and obligations under this Contract to third parties without the Contracting Officer's prior, written consent. The Contracting Officer may recognize a third party as successor in interest to this Contract in the event of a transfer of all or substantially all of the Contractor's assets, a change in a division of the Contractor involved in the performance of this Contract, or if a parent company provides performance guarantee(s) under this Contract, (i.e., sales of assets, transfer of assets pursuant to merger or consolidation, or incorporation of a proprietorship or partnership). Such recognition shall be at the Contracting Officer's discretion after review of the facts and circumstances surrounding each request. The Contracting Officer, at his or her discretion, may conduct an evaluation of the successor party's capability to perform this Contract in the same manner and to the same extent that he or she conducted a responsibility determination as part of the original solicitation for this Contract. Should the Contracting Officer, for any reason, not recognize such a successor in interest, he or she may terminate this Contract.

- (b) Any attempt to transfer by assignment that the Contracting Officer does not authorize shall constitute a material breach of this Contract and the Contracting Officer may terminate this Contract in accordance with the "Termination for Default" article set forth in this Contract.

- (c) Nothing contained herein shall be deemed to preclude the Contractor's assignment of claims for monies due or to be become due to it under this Contract to a bank, trust company or other financing institution, including any Federal lending agency, upon written notice of such assignment to the Contracting Officer.

5. DISPUTES- FTA

- (a) Any dispute concerning a question of fact arising under or related to this Contract that is not disposed of by agreement, shall be decided by the Contracting Officer, who shall reduce his/her decision to writing and mail or otherwise furnish a copy thereof to the Contractor. The Contracting Officer's decision shall be final and conclusive unless, within thirty (30) calendar days from the date of its receipt, the Contractor mails or otherwise furnishes to the Contracting Officer, a written notice of appeal addressed to the Authority Board of Directors. Such notice must indicate that an appeal is intended and must reference the decision and Contract number. The decision of the Board of Directors or its duly authorized representative for the determination of such appeals shall be final and conclusive, unless in proceedings initiated by either party for review of such decision in a court or board of competent jurisdiction, it determines that the decision was fraudulent, or capricious, or arbitrary, or so grossly erroneous as necessarily to imply bad faith, or not supported by substantial evidence. In any appeal under this article, the appellant shall be afforded an opportunity to be heard and offer evidence in support of its appeal. Pending final decision of a dispute hereunder, the Contractor shall proceed diligently with the performance of this Contract in accordance with the Contracting Officer's decision. The Armed Services Board of Contract Appeals (ASBCA) is the Board of Directors' authorized representative for final decisions on an appeal.
- (b) This "Disputes" article does not preclude consideration of questions of law in connection with decisions provided for in paragraph (a) above. Nothing in the Contract, however, shall be construed as making final the decisions of the Board of Directors or its representative on questions of law.

6. EQUAL EMPLOYMENT OPPORTUNITY REQUIREMENTS FOR CONSTRUCTION ACTIVITIES

When undertaking "construction" as recognized by the U.S. Department of Labor (U.S. DOL), the Contractor agrees to comply with U.S. DOL regulations "Office of Federal Contract Compliance Programs, Equal Employment Opportunity, Department of Labor," 41 C.F.R. Part 60, and Executive Order 11246 "Equal Employment Opportunity," as amended by Executive Order 11375, "Amending Executive Order 11246, Relating to Equal Employment Opportunity," 42 U.S.C. § 2000 (e) note.

CHAPTER VII – INDEMNIFICATION/INSURANCE/RISK OF LOSS

1. INDEMNIFICATION

- (a) Contractor shall indemnify, defend and hold harmless the Authority, its Board members, employees and agents, from all liabilities, obligations, damages, penalties, claims, costs, charges and expenses (including reasonable attorneys’ fees), of whatsoever kind and nature for injury, including personal injury or death of any person or persons, and for loss or damage to any property, including the property of the Contractor and the Authority, occurring in connection with, or in any way arising out of the use, occupancy and performance of the work and/or any acts in connection with activities to be performed under this Contract, unless the loss or damage is due to the sole negligence of the Authority. Nothing in the preceding sentence shall be deemed to relieve Contractor from ultimate liability for any of its obligation under this Contract.
- (b) Contractor shall indemnify, defend and hold harmless the Authority, its Board members, employees and agents, against any and all claims, liabilities, losses, demands, damages, penalties, costs, charges, remedial costs, environmental claims, fees or other expenses including attorneys’ fees, related to, arising from or attributable to any effluent or other hazardous waste, residue, contaminated soil or other similar material discharged from, removed from, or introduced on, about or under the job site. The foregoing indemnity does not apply to loss or damage due to preexisting conditions, whether known or unknown.
- (c) If any action or proceeding relating to this indemnification is brought against the Authority, then upon written notice from the Authority to the Contractor, the Contractor shall, at its own expense, resist or defend such action or proceeding by counsel approved by the Authority in writing. No approval of counsel shall be required where the cause of action is resisted or defended by counsel of any insurance carrier obligated to resist or defend the same. The Authority reserves the right to use its own counsel under this indemnity at Contractor’s sole cost and expense.
- (d) Contractor understands and agrees to its responsibility to provide indemnification to the Authority pursuant to this clause. The provision of insurance, while anticipated to provide a funding source for this indemnification, is in addition to any indemnification requirements. The failure of Contractor’s insurance to fully fund any indemnification shall not relieve the Contractor of any obligation hereunder.

2. INSURANCE REQUIREMENTS

I. MINIMUM REQUIRED INSURANCE: MINIMUM LIMITS OF INSURANCE

INSURANCE TYPE	LIMITS	BASIS
Workers’ Compensation	Statutory	
Employers’ Liability	\$500,000	Each Accident
	\$500,000	Disease Policy Limit
	\$500,000	Disease Each Employee

Business Auto Liability		
	\$1,000,000	Combined Single Limit

II. MINIMUM REQUIRED INSURANCE: MINIMUM INSURANCE COVERAGES AND COVERAGE PROVISIONS

- 1) Contractor is required to maintain the prescribed insurance outlined in this Exhibit A during the entire period of performance under this contract. Notice to Proceed (NTP) will not be issued until all required insurance has been accepted by WMATA.
- 2) The prescribed insurance coverage and limits of insurance are minimum required coverages and limits. Contractor is encouraged, at its sole cost and expense, to purchase any additional insurance coverages and or limits of insurance that Contractor deems prudent and necessary to manage risk in the completion of this contract.
- 3) Upon written request from WMATA, contractor shall provide copies of any requested insurance policies, including applicable endorsements, within five (5) business days of such request.
- 4) Receipt, review or communications regarding certificates of insurance (COI), insurance policies, endorsements, or other materials utilized to document compliance with these Minimum Insurance Requirements does not constitute acceptance by WMATA.
- 5) Insurance companies must be acceptable to WMATA and must have an A. M. Best rating of at least A- VII.
- 6) Unless otherwise noted, "Claims Made" insurance policies are not acceptable.
- 7) Any insurance policy utilizing a Self-Insured Retention (SIR) requires written approval from WMATA.
- 8) Contractor must incorporate these Minimum Insurance Requirements into contract requirements of all subcontractors of every tier; however, Contractor, at its sole peril, may amend these Minimum Insurance Requirements for its subcontractors, but doing so does not relieve Contractor from its respective liability to WMATA.
- 9) Compliance with these Minimum Insurance Requirements does not relieve Contractor from Contractor's respective liability to WMATA, even if that liability exceeds the Minimum Insurance Requirements.

III. COVERAGE-SPECIFIC REQUIREMENTS

Business Auto Liability

- 1) Business Auto Liability insurance shall be written on ISO Business Auto Coverage Form CA 00 01 03 06, or its equivalent. Equivalency determination shall be made in WMATA's sole and unreviewable discretion.

- 2) Policy shall be endorsed with Additional Insured Endorsement(s) in compliance with the “Additional Insured” Section below.
- 3) Policy shall be endorsed with a Waiver of Subrogation Endorsement(s) in compliance with the “Waiver of Subrogation” section below.
- 4) Business Auto Liability minimum Combined Single Limit requirements may be obtained through the combination of a primary business auto liability policy and an Umbrella/Excess Liability policy provided that the Umbrella/Excess Liability policy complies with items 2 and 3 above.
- 5) MCS-90 Endorsement for work involving the transportation or disposal of any hazardous material or waste off of the jobsite. If the MCS-90 Endorsement is required, minimum auto liability limits of \$5,000,000 per occurrence are also required as is form CA 99 48, broadened coverage for pollution liability.
- 6) Non-Owned Disposal Site (NODS) Endorsement providing coverage for the Contractor’s legal liability arising out of pollution conditions at the designated non-owned disposal site.

IV. OTHER

Additional Insured

- 1) Contractor and subcontractors of every tier are required to add WMATA and WMATA Board of Directors as additional insured on all required insurance including excess liability policies, with the exception of Workers’ Compensation and Professional Liability.
- 2) Coverage provided to Additional Insured shall be primary and non-contributory to any other insurance available to the Additional Insured, including coverage afforded to the WMATA as an additional insured by subcontractors, and from other third parties.
- 3) Coverage provided to any Additional Insured shall be for claims arising out of both ongoing operations and products and completed operations hazard.
- 4) Coverage available to any Additional Insured under the products and completed operations hazard can only be limited to the applicable statute of repose in the jurisdiction(s) where the contract scope of work takes place.
- 5) Commercial General Liability and Umbrella/Excess Liability forms must provide defense coverage for additional insureds. The Additional Insured Endorsement shall provide coverage for Ongoing as well as Products and Completed Operations with no limitation on when claims can be made.

Waiver of Subrogation

Contractor and subcontractors of every tier are required to have all insurance policies except Professional Liability endorsed to waive the respective insurance company’s rights of recovery against WMATA, and the WMATA Board of Directors.

- 1) Waiver shall be provided on an endorsement that is acceptable to WMATA.

Certificate of Insurance (COI)

Contractor shall provide WMATA an ACORD Certificate of Insurance (COI) and copies of all required endorsements as evidence that the insurance requirements of this Section have been satisfied. Certificates of Insurance shall be sent to WMATA.

The Certificate Holder box should read:

Washington Metropolitan Area Transit Authority
Office of Insurance, Room 8F
600 Fifth Street, NW
Washington, DC 20001

Additionally:

- 1) Proposed material modifications to required insurance, including notice of cancellation, must be received by WMATA in writing at least 30 days prior to the effective date of such change or cancellation.
- 2) WMATA's receipt of copies of any COI, policy endorsements or policies does not relieve Contractor of the obligation to remain in compliance with the requirements of this Section at all times. Contractor's failure to comply with these insurance requirements shall constitute a material breach of this Contract.
- 3) Receipt of the COI does not constitute acceptance of the insurance outlined above.

3. TITLE AND RISK OF LOSS

- (a) Unless this Contract specifically provides for earlier passage of title to deliverables (including documents, reports, and data) or other items resulting from this Contract, title shall pass to the Authority upon acceptance, regardless of when or where the Authority takes physical possession. Risk of loss, theft, destruction of, or damage to, such deliverables or other items remains with the Contractor, until the transfer of title or at the time when the Authority takes physical possession, whichever is later.
- (b) In the event of loss or damage to any deliverable or other item of work, prior to the time when the Authority takes physical possession, the Contractor agrees to repair or replace it as soon as reasonably possible to restore the item to the same condition that pre-existed the loss or damage, in accordance with all requirements of this Contract, without cost to the Authority. Nothing contained herein shall be deemed to require the Contractor's repair or replacement of any loss or damage caused solely by the Authority's acts or omissions.
- (c) The following clause applies, if and when the Contractor performs work on its own property.
 - (1) WMATA retains title to all WMATA-furnished property, including, but not limited to _____. WMATA furnished property shall not become a fixture, or lose its identity as personal property by being attached to any real property. The Contractor shall use WMATA's property, furnished under this Contract, only for performing this Contract, unless the Contracting Officer approves otherwise. Modifications or alterations of WMATA property are

prohibited, unless they are (i) Reasonable and necessary due to the technical specifications for this Contract; (ii) Required for normal maintenance; or (iii) Otherwise authorized by the Contracting Officer. Risk of loss is on the Contractor for WMATA-furnished property, i.e. the Contractor is liable for loss, theft, damage or destruction to WMATA property while it is in the Contractor's possession or control. The Contractor shall take all reasonable actions necessary to protect WMATA's property from loss, theft, damage or destruction. The Contractor shall do nothing to prejudice WMATA's rights to recover against third parties for any loss, theft, damage or destruction to WMATA's property.

4. TRANSIT EMPLOYEE PROTECTIVE ARRANGEMENTS – FTA
Not Applicable

5. VETERANS PREFERENCE- FTA

A veterans preference, as provided by 49 U.S.C. §5325(k), to the extent practical, (1) Will give a hiring preference to veterans, as defined in 5 U.S.C. §2108, who have the skills and abilities required to perform construction work required under a third party contract in connection with a Capital Project supported with Federal assistance appropriated or made available for 49 U.S.C. chapter 53, and (2) Will not require an employer to give a preference to any veteran over an equally qualified applicant who is a member of any racial or ethnic minority, female, and individual with a disability, or former employee.

6. INAPPLICABILITY OF CLAUSES REQUIRING UNAUTHORIZED OBLIGATIONS

- (a) Except where the Chief Procurement Officer specifically agrees in writing, when any supply or service acquired under this Contract is subject to any End User License Agreement (EULA), Terms of Service (TOS), Master Agreement, Terms and Conditions or similar legal instrument or agreement, that includes any clause requiring WMATA to indemnify the Contractor or any person or entity for damages, costs, fees, or any other loss or liability or that would create an unauthorized obligation, the following shall govern:
 - (i) Any such clause is unenforceable against WMATA.
 - (ii) Neither WMATA nor any authorized end user shall be deemed to have agreed to such clause by virtue of it appearing in the EULA, TOS, or similar legal instrument or agreement. If the EULA, TOS, or similar legal instrument or agreement is invoked through an "I agree" click box or other comparable mechanism (e.g., "click-wrap" or "browse-wrap" agreements), execution does not bind WMATA or any WMATA authorized end user to such clause.
 - (iii) Any such clause is deemed to be stricken from the EULA, TOS, or similar legal instrument or agreement.
- (b) When any supply or service acquired under this Contract is subject to any End Use License Agreement (EULA), Terms of Service (TOS), or similar legal instrument or

agreement, any clause requiring WMATA to pay pre-judgment interest, taxes to which it is exempt, or automatic fines is void and without effect.

CHAPTER VIII – INTELLECTUAL PROPERTY RIGHTS

1. PATENT INDEMNITY

The Contractor shall indemnify the Authority and its Board members, agents and employees against liability, including costs, for infringement of any United States patent (except a patent issued upon an application that is now or may hereafter be withheld from issue pursuant to a Secrecy Order under 35 U.S.C. § 181) arising out of the manufacture or delivery of supplies, the performance of services, or the construction, alteration, modification, or repair of real property under this Contract. If the Contractor is not the original equipment manufacturer (OEM) for a manufactured product purchased under this Contract, it will ensure that the patent holder provides indemnity to WMATA under this article. This indemnity shall not apply unless the Contractor is informed as soon as practicable by the Authority of the suit or action alleging such infringement, and is given such opportunity as is afforded by applicable laws, rules, or regulations to participate in the defense thereof. Such indemnity shall not apply to:

- (1) An infringement resulting from compliance with the Contracting Officer's specific written instructions directing a change in the supplies to be delivered or in the materials or equipment to be used, or directing a manner or performance of the Contract not normally used by the Contractor;
- (2) An infringement resulting from addition to, or change in, such supplies or components furnished or construction work performed that was made subsequent to delivery or performance by the Contractor; or
- (3) A claimed infringement that is unreasonably settled without the Contractor's consent, unless required by final decree of a court of competent jurisdiction.

2. SET-OFF

The Authority has common law, equitable and statutory rights to set-off. These rights shall include, but are not limited to, the Authority's right to set-off any monies due to the Contractor under this Contract, by any amounts due and owing to the Authority with regard to, any Contract with the Authority, plus any amounts due and owing to the Authority for any other reason including, without limitation, tax delinquencies, fee delinquencies or monetary penalties relative thereto. The Authority shall exercise its set-off rights in accordance with applicable law and practices including, in cases of set-off pursuant to an audit, the finalization of such audit by the Authority, its representatives, or the Federal Government.

3. Not Applicable

4. RIGHTS IN TECHNICAL DATA – UNLIMITED

- (b) The term technical data as used in this article means technical writings, computer software, sound recordings, pictorial reproductions, drawings, or other graphic representations and works of a technical nature, whether or not copyrighted, that are specified to be delivered pursuant to this Contract. The term does not include financial reports, cost analyses, and other information incidental to Contract

administration. "Computer software" as used in this article means computer programs, computer data bases, and documentation thereof.

- (b) The Authority or its designated representative shall have the right to use, duplicate or disclose technical data, including computer software, in whole or in part, in any manner and for any purpose whatsoever, and to have or permit others to do so that is contained in or derived from:
 - (1) Any manuals, instructional materials prepared for installation, operation, maintenance or training purposes;
 - (2) Technical data pertaining to end items, components or processes that were prepared for the purpose of identifying sources, sizes, configurations, mating and attachment characteristics, functional characteristics and performance requirements ("form, fit and function" data such as , specification control drawings, catalog sheets, and outline drawings Except for the computer software, it means data identifying sources, functional characteristics, and performance requirements, but specifically excludes the source code, algorithms, processes, formulae, and flow charts of the software.);
 - (3) Other technical data that the Contractor or subcontractor , normally furnishes without restriction; ;
 - (4) Other specifically described technical data that the parties have agreed will be furnished without restriction;
 - (5) All computer software regardless of whether it is technical data as defined in this article, including the source code, algorithms, processes, formulae, and flow charts, that the Contractor developed or materially modified for the Authority or for which the Authority is required by Federal law or regulation to provide a royalty-free, irrevocable and nonexclusive license to the Federal government.

- (c) The Authority shall have the right to use, duplicate, or disclose technical data other than as defined in paragraph (a), in whole or in part. Such technical data shall not, without the written permission of the party furnishing such technical data, be:
 - (1) Released or disclosed, in whole or in part, outside of the Authority,
 - (2) Used, in whole or in part, by the Authority for manufacturing, or
 - (3) Used by a party other than the Authority except for: (i) emergency repair or overhaul, (ii) where the item or process concerned is not otherwise reasonably available to the Authority to enable timely performance of this work, or (iii) administration of this Contract or the inspection of any products produced under it, where the third party has a written contract with the Authority to perform these efforts. In all cases described in this subsection, the release or disclosure outside of the Authority shall be subject to a nondisclosure agreement.

- (d) Technical data provided in accordance with paragraph (c) shall be identified with a legend that suitably recites this limitation. This article shall not impair the Authority's right to use similar or identical data acquired from other sources.

- (e) Where any item is purchased as a separate line item in this Contract, that purchase includes all integral parts of that item, including any computer software, source code, algorithms, processes, formulae, and flow charts. The Authority has full rights to use, duplicate or disclose any or all parts of the item, including computer software, in whole or in part, in any manner and for any purpose whatsoever, and to permit others to do so. Should disclosure of the computer software be required only under this paragraph, then the Contracting Officer may waive the provisions of this paragraph if he or she certifies in writing that the item is commercially available from multiple sources and will be fully compatible with existing Authority property.
- (f) Material covered by copyright:
 - (1) The Contractor grants to the Authority, and to its Board members, agents and employees acting within the scope of their official duties, a royalty-free, nonexclusive and irrevocable license throughout the world for the Authority's purposes to publish, translate, reproduce, deliver, perform, dispose of, and to authorize others so to do, all technical data and computer software covered by subsection (b) (5) now or hereafter covered by copyright.
 - (2) No such copyrighted matter shall be included in (i) technical data or (ii) computer software covered by subsection (b) (5) furnished hereunder without the written permission of the copyright owner for the Authority to use such copyrighted matter in the manner above described.
 - (3) The Contractor shall report to the Authority promptly and in reasonable written detail each notice or claim of copyright infringement it receives regarding any technical data or computer software covered by subsection (b)(5) provided to the Authority.
- (g) Relation to patents: Nothing contained in this article shall imply a license to the Authority under any patent, or be construed as affecting the scope of any license or other right otherwise granted to the Authority under any patent.
- (h) Any dispute under this article shall be subject to the "Disputes" article of this Contract.
- (i) The Contracting Officer may retain from payment up to ten percent (10%) of the Contract price until final delivery and acceptance of the technical data defined in this Article and as required to be furnished by the Price Schedule or the Contract's specifications.

5. NOTICE AND ASSISTANCE REGARDING PATENT AND COPYRIGHT INFRINGEMENT [SUPPLIES]

- (a) The Contractor shall report to the Contracting Officer, promptly and in reasonable written detail, each notice or claim of patent or copyright infringement based on this Contract, once the Contractor is notified thereof.
- (b) In the event of any claim or suit against the Authority based on any alleged patent or copyright infringement arising out of this Contract or out of the use of any supplies furnished or services performed hereunder, the Contractor shall furnish to the Contracting Officer, all evidence and information in its possession pertaining to such

suit or claim. Such evidence and information shall be furnished at the Contractor's expense since the Contractor has agreed to indemnify the Authority for such infringement claims.

- (c) This article shall be included in all subcontracts.

CHAPTER IX – ADDITIONAL COVENANTS/LEGAL REQUIREMENTS

1. NONDISCRIMINATION ASSURANCE- FTA

- (a) *Nondiscrimination Assurance.* In accordance with Title VI of the Civil Rights Act, as amended, 42 U.S.C. §2000 (d), section 303 of the Age Discrimination Act of 1975, as amended, 42 U.S.C. §6102, section 202 of the American with Disabilities Act of 1990, 42 U.S.C. §12132, D.C. law and Federal transit law at 49 U.S.C. §5332, the Contractor, sub-recipient, or subcontractor agrees that it will not discriminate against any employee or applicant for employment because of race, color, creed, religion, national origin, sex, age, sexual preference, gender identity and/or disability. In addition, the Contractor, sub-recipient, or subcontractor agrees to comply with applicable Federal implementing regulations and other regulations that FTA may issue.

- (b) *Equal Employment Opportunity.* The following equal employment opportunity requirements apply to this Contract.
 - (1) *Race, Color, Creed, National Origin, Sex.* In accordance with Title VII of the Civil Rights Act, as amended, 42 U.S.C. §2000(e), and Federal transit laws at 49 U.S.C. §5332, the Contractor agrees to comply with all applicable equal opportunity requirements of the U.S. Department of Labor (U.S. DOL) including, but not limited to "Office of Federal Contract Compliance Programs, Equal Employment Opportunity, Department of Labor, " 41 C.F.R. Part 60 *et. seq.*, [implementing Executive Order No. 11246, "Equal Employment Opportunity," as amended by Executive Order No. 11375, "Amending Executive Order 11246 Relating to Equal Employment Opportunity," 42 U.S.C. § 2000(e) note], and with any applicable Federal statutes, executive orders, regulations, and Federal policies that may in the future affect construction activities undertaken in the course of this Contract. The Contractor agrees to take affirmative action to ensure that applicants are employed, and that employees are treated during employment without regard to their race, color, creed, national origin, sex or age. Such action shall include, but not be limited to, the following: employment, upgrading, demotion or transfer, recruitment or recruitment advertising, layoff or termination; rates of pay or other forms of compensation; and selection for training, including apprenticeship. In addition, the Contractor agrees to comply with any implementing requirements that FTA may issue.

 - (2) *Age.* In accordance with Section 4 of the Age Discrimination in Employment Act of 1967, as amended, 29 U.S.C. § 623 and Federal transit law at 49 U.S.C. § 5332, the Contractor agrees to refrain from discrimination against present and prospective employees for reason of age. In addition, the Contractor agrees to comply with any implementing requirements that FTA may issue.

 - (3) *Disabilities.* In accordance with section 102 of the Americans with Disabilities Act, as amended, 42 U.S.C. §12112, the Contractor agrees that it will comply with the requirements of U.S. Equal Employment Opportunity Commission, "Regulations to Implement the Equal Employment Provisions of the Americans with Disabilities Act," 29 C.F.R. Part 1630,

pertaining to employment of persons with disabilities. In addition, the Contractor agrees to comply with any implementing requirements that FTA may issue.

- (c) The Contractor also agrees to include all of these requirements in each subcontract financed, in whole or in part, with Federal assistance provided by FTA, modified only, if necessary, to identify the affected parties.
- (d) Failure by the Contractor, sub-recipient, or subcontractor to carry out these requirements is a material breach of this Contract, that may result in the termination or such other remedy as the Authority deems appropriate.

2. CONTRACT WORK HOURS AND SAFETY STANDARDS ACT-OVERTIME COMPENSATION

This Contract, to the extent that it is of a character specified in the Contract Work Hours and Safety Standards Act (40 U.S.C. §§ 327-333), is subject to the following provisions and to all other applicable provisions and exceptions of such Act and the regulations of the U.S. Secretary of Labor thereunder.

- (a) *Overtime requirements.* No Contractor or subcontractor contracting for any part of the Contract work that may involve the employment of laborers, mechanics, apprentices, trainees, watchmen, and guards shall require or permit any such employee in any workweek in which he or she is employed to work in excess of forty (40) hours in such work week on work subject to the provisions of the Contract Work Hours and Safety Standards Act unless such employee receives compensation at a rate not less than one and one-half (1 ½) times his or her basic rate of pay for all hours worked in excess of forty (40) hours in such work week.
- (b) *Violation. Liability for Unpaid Wages-Liquidated damages.* In the event of any violation of paragraph (a) the Contractor and any subcontractor responsible therefore shall be liable to any affected employee for his or her unpaid wages. In addition, such Contractor and subcontractor shall be liable to the Authority for liquidated damages. Liquidated damages shall be computed with respect to each individual laborer, mechanic, apprentice, trainee, watchman or guard employed in violation of paragraph (a) in the sum of \$10 for each calendar day on which such employee was required or permitted to be employed on such work in excess of his or her standard work week of forty (40) hours without payment of the overtime wages required by paragraph (a).
- (c) *Withholding for unpaid wages and liquidated damages.* The Contracting Officer may withhold from the Contractor, such sums as he or she determines to be necessary to satisfy any liabilities of such Contractor or subcontractor for unpaid wages and liquidated damages as provided in paragraph (b).
- (d) *Subcontracts.* The Contractor shall insert this article in all subcontracts at any tier. Contractor shall also require subcontractors to include this clause in any lower tier subcontracts. The Contractor shall be responsible for compliance by any and all subcontractors at every tier.

- (e) *Records.* The Contractor shall maintain payroll records containing the information specified in 29 C.F.R. § 516.2(a). Such records shall be preserved for three (3) years from the completion of this Contract.

3. WALSH-HEALEY PUBLIC CONTRACTS ACT

If this Contract is for materials, supplies, or equipment in an amount that may exceed \$10,000 and is subject to the Walsh-Healey Public Contracts Act, as amended (41 U.S.C. §§ 35-45) the following terms and conditions apply:

- (a) All stipulations required by the Act and regulations issued by the U.S. Secretary of Labor (41 C.F.R. Part 50) are incorporated by reference. These stipulations are subject to all applicable rulings and interpretations of the U.S. Secretary of Labor that are now, or may hereafter, be in effect.
- (b) All employees whose work relates to this Contract shall be paid not less than the minimum wage prescribed by the U.S. Secretary of Labor (41 C.F.R. § 50-202.2). Learners, student learners, apprentices, and certain handicapped workers may be employed at less than the prescribed minimum wage (41 C.F.R. § 50-202.3) to the same extent that such employment is permitted under Section 14 of the Fair Labor Standards Act (41 U.S.C. § 40).

4. DAVIS-BACON ACT- FTA

Not Applicable

5. COPELAND ANTI-KICKBACK ACT – FTA

- (a) The Contractor agrees to comply with section 1 of the Copeland “Anti-Kickback Act,” 18 U.S.C. § 874 that prohibits anyone from inducing, by any means, any person employed on construction, prosecution, completion or repair of a Federally assisted building or work, to give up any part of his or her compensation to which he or she is entitled. Contractor further agrees to comply with section 2 of the Act, 40 U.S.C. § 3145, as amended, and implementing U.S. DOL regulations, “Contractors and Subcontractors on Public Buildings or Public Works Financed in Whole or in Part, by Loans or Grants from the United States.” Contractor agrees to comply with 29 C.F.R. Part 3 which imposes record keeping requirements for all such contracts in excess of \$2,000.
- (b) Contractor shall insert this clause in all subcontracts, and require that subcontractors insert this clause in any and all of their subcontracts, at any tier.

6. CONVICT LABOR

- (a) Except as provided in paragraph (b), the Contractor shall not employ in the performance of this Contract any person undergoing a sentence of imprisonment imposed by any court of the Federal Government, a State, the District of Columbia, Puerto Rico, the Northern Mariana Islands, American Samoa, Guam or the U.S. Virgin Islands.
- (b) The Contractor is not prohibited from employing persons:

- (1) On parole or probation to work at paid employment during the term of their sentence;
- (2) Who have been pardoned or who have served their terms; or
- (3) Confined for violation of the laws of the Federal Government, the states, the District of Columbia, Puerto Rico, the Northern Mariana Islands, American Samoa, Guam, or the U.S. Virgin Islands who are authorized to work at paid employment in the community under the laws of such jurisdiction, if—
 - (a) The worker is paid or is in an approved work or training program on a voluntary basis;
 - (b) Representatives of the local union’s central bodies or similar labor union organizations have been consulted;
 - (c) Such paid employment will not result in the displacement of employed workers, or be applied in skills, crafts, or trades where there is a surplus of available gainful labor in the locality, or impair existing contracts or services;
 - (d) The rates of pay and other conditions of employment will not be less than those paid or provided for work of a similar nature in the locality where the work is being performed; and
 - (e) The Attorney General of the United States has certified that the work-release laws or regulations of the jurisdiction involved are in conformity with the requirements of Executive Order 11755, as amended by Executive Orders 12608 and 12943.

7. COVENANT AGAINST CONTINGENT FEES

- (a) The Contractor warrants that no person or selling agency has been employed or retained to solicit or secure this Contract upon an agreement for a commission, percentage, brokerage or contingent fee, excepting bona fide employees or bona fide, established commercial or selling agencies maintained by the Contractor for the purpose of securing business. For breach of this warranty, the Authority shall have the right to terminate this Contract without liability or, in its discretion, to deduct from the Contract price, or otherwise recover, the full amount of such commission, percentage, brokerage, or contingent fee, if no fraud is suspected.
- (b) If fraud is suspected, the Authority’s only remedy prior to final adjudication by a court of competent jurisdiction is to report the matter to WMATA’s Office of Inspector General (OIG), the U.S. Department of Transportation’s Office of Inspector General (DOT-OIG), the Offices of Inspectors General of any agency providing funding under this Contract and/or appropriate Federal, state and/or local law enforcement authorities.

8. SEAT BELT USE POLICY

The Contractor agrees to comply with terms of Executive Order No. 13043 “Increasing Seat Belt Use in the United States” and is encouraged to include these requirements in each subcontract awarded for work relating to this Contract.

9. SENSITIVE SECURITY INFORMATION

The Contractor must protect, and take measures to assure that its subcontractors at each tier protect, "sensitive information" made available during the course of administering an Authority contract or subcontract in accordance with 49 U.S.C. Section 40119(b) and implementing DOT regulations, "Protection of Sensitive Security Information," 49 CFR Part 15, and with 49 U.S.C. Section 114(s) and implementing Department of Homeland Security regulations, "Protection of Sensitive Security Information," 49 CFR Part 1520.

10. LAWS AND REGULATIONS

The Contractor shall be responsible to comply with any applicable State of Maryland, Commonwealth of Virginia, District of Columbia, Federal and local laws and regulations governing the services and/or supplies to be provided under this Contract. Further, the Contractor shall be responsible to obtain, at its own cost and expense, any and all licenses/permits required to transact business in any political jurisdictions where work will be performed.

11. HAZARDOUS MATERIAL IDENTIFICATION AND MATERIAL SAFETY DATA

- (a) The Contractor agrees to submit a Material Safety Data Sheet (U.S. Department of Labor Form OSHA-20), as prescribed in Federal Standard No. 313B, for all hazardous materials five (5) days before delivery of the material, whether or not listed in Appendix A of the Standard. This obligation applies to all materials delivered under this Contract that involve exposure to hazardous materials or items containing these materials.
- (b) "Hazardous material," as used in this clause, is defined in Federal Standard No. 313B, in effect on the date of this Contract.
- (c) Neither the requirements of this clause nor the Authority's acts or omissions shall relieve the Contractor of any responsibility or liability for the safety of Authority's, personnel or property.
- (d) Nothing contained in this article shall relieve the Contractor from complying with applicable Federal, state, and local laws, codes, ordinances, and regulations (including the requirement to obtain licenses and permits) in connection with hazardous materials.
- (e) The Authority's rights in data furnished under this Contract regarding hazardous materials are as follows:
 - (1) To use, duplicate and disclose any data to which this clause is applicable. The purposes of this right are to (a) apprise personnel of the hazards that they may be exposed to in using, handling, packaging, transporting, or disposing of hazardous materials (b) obtain medical treatment for those affected by the materials; and (c) have others use, duplicate, and disclose the data for the Authority for these purposes.
 - (2) To use, duplicate, and disclose data furnished under this article in precedence over any other provision of this Contract providing for rights in data.

- (3) The Authority is not precluded from using similar or identical data acquired from other sources.
- (4) The data shall not be duplicated, disclosed, or released outside of the Authority, in whole or in part, for any acquisition or manufacturing purpose, if the following legend is marked on each piece of data to which this clause applies -

"This data furnished under this Contract shall not be used, duplicated, or disclosed for any acquisition or manufacturing purpose without the Contracting Officer's permission. This legend shall be marked on any reproduction of this data."
- (5) The Contractor shall not place any restrictive legend on any data that (i) the Contractor or any subcontractor previously delivered to the Authority without limitations; or (ii) should be delivered without limitations under the "Rights in Technical Data" clause.
- (6) The Contractor shall insert this article including this paragraph, with appropriate changes in the designation of the parties, in subcontracts at any tier (including purchase designations or purchase orders) under this Contract involving hazardous materials.

12. LIVING WAGE

- (a) The Authority's Living Wage Policy and implementing regulations apply with respect to all contracts for services (including construction) awarded in an amount that exceeds \$150,000 in a twelve (12) month period. If this Contract meets those criteria, the following requirements are applicable:
- (b) The Authority's living wage rate is \$13.85 per hour, and may be reduced by the Contractor's per-employee cost for health insurance.
- (c) The Contractor shall:
 - (1) Pay the Authority's living wage rate, effective during the time the work is performed, to all employees who perform work under this Contract;
 - (2) Include this "Living Wage" article in all subcontracts that exceed \$150,000 in a twelve (12) month period awarded under this Contract;
 - (3) Maintain payroll records, in accordance with the requirements of this Contract, and include a similar provision in affected subcontracts that requires the subcontractor to maintain its payroll records for the same length of time; and
 - (4) Certify with each monthly invoice that the Authority's living wage rate was paid to affected employees, or if applicable, certify prior to Contract award or Contract extension, if any, that one or more of the exemptions in paragraph (d) below applies.
- (5) The Contractor shall not split or subdivide this Contract, pay an employee through a third party, or treat an employee as a subcontractor or independent contractor to avoid compliance with this "Living Wage" article

- (d) Exemptions to this “Living Wage” article include:
 - (1) Contracts and agreements subject to higher wage rates required by Federal law or collective bargaining agreements;
 - (2) Contracts or agreements for regulated utilities;
 - (3) Emergency services to prevent or respond to a disaster or imminent threat to public health and safety;
 - (4) Contractor employees who work less than full time; and
 - (5) Contractors who employ fewer than ten (10) employees.

- (e) The Authority may adjust the living wage rate effective in January of each year. The adjustment will reflect the average living wage rate among Metro’s Compact jurisdictions with living wage rates. If after Contract award the living wage rate increases, the Contractor is entitled to an equitable adjustment to the Contract price in the amount of the increase for employees who are affected by the escalated wage.

- (f) Failure to comply with the Authority’s Living Wage Policy shall result in the Authority’s right to exercise available Contract remedies, including Contract termination, where no fraud is suspected.

- (g) If fraud is suspected, the Authority’s only remedy prior to adjudication by a court of competent jurisdiction is to report the matter to WMATA’s Office of Inspector General (OIG), the U.S. Department of Transportation’s Office of Inspector General (DOT-OIG), the Offices of Inspectors General of any state or Federal agency providing funding under this Contract and/or appropriate Federal, state and/or local law enforcement authorities.

13. METRIC SYSTEM

To the extent the Federal Government directs, the Contractor agrees to use the metric system of measurement in its Contract activities, in accordance with the Metric Conversion Act, as amended by the Omnibus Trade and Competitiveness Act, 15 U.S.C. § 205 (a) *et. seq.*; Executive Order No. 12770, “Metric Usage in Federal Government Programs,” 15 U.S.C. § 205(a) note; and applicable U.S. DOT or FTA regulations in accordance with applicable Federal directives. As practicable and feasible, the Contractor agrees to supply products and services with dimensions expressed in the metric system of measurement. Metric usage shall not be required to the extent that such use is impractical or is likely to cause significant inefficiencies or loss of markets to United States firms.

14. MANDATORY DISCLOSURE

The Contractor shall timely disclose, in writing, to WMATA’s Office of the Inspector General (OIG), with a copy to the Contracting Officer, whenever, in connection with the award, performance, or closeout of this Contract or any subcontract hereunder, the Contractor has credible evidence that a principal, employee, agent, or subcontractor of the Contractor has committed—

- (a) A violation of Federal criminal law involving fraud, conflict of interest, bribery, or gratuity violations found in Title 18 of the United States Code; or

- (b) A violation of the civil False Claims Act (31 U.S.C. §§ 3729-3733).
 - (1) WMATA, to the extent permitted by law and regulation, will safeguard and treat information obtained pursuant to the Contractor's disclosure as confidential where the information has been marked "confidential" or "proprietary" by the company. To the extent permitted by the law and regulation, such information will not be released by WMATA to the public pursuant to a Public Access to Records (PARP) request. WMATA may transfer documents provided by the Contractor to any department or agency within the state, Federal or local government, if the information relates to matters within the organization's jurisdiction.
 - (2) If the violation relates to an order against a government-wide acquisition contract, a multi-agency contract, a multiple-award schedule contract such as the Federal Supply Schedule, or any other procurement instrument intended for use by multiple agencies, the Contractor shall notify the OIG of the ordering agency and the OIG of the agency responsible for the basic contract.

15. WHISTLEBLOWER PROTECTION – FEDERAL

- (a) The Contractor and its subcontractors shall encourage their employees and independent contractors to report information without fear of actual or threatened discrimination, retaliation or reprisal that they in good faith reasonably believe is evidence of gross mismanagement; gross misuse or waste of public resources or funds; fraud; violation of law; abuse of authority in connection with the conduct of WMATA operations or contracts; or a substantial and specific danger to health, security or safety. The Contractor and its subcontractors shall notify their employees that they may make reports under this paragraph to:
 - (1) WMATA's Office of Inspector General (OIG), in person, in writing, through the OIG Hotline (888-234-2374) or email wmata-oig-hotline@verizon.net or by any other reasonable means;
 - (2) WMATA's Metro Transit Police Department (MTPD), in person, by telephone (202-962-2121) or by any other reasonable means, or to the OIG, if the information constitutes a potential violation of criminal law;
 - (3) WMATA's Chief Safety Officer, in person, in writing, through the SAFE Hotline (202-249-7233) or email safety@wmata.com, or by any other reasonable means; or
 - (4) Any other official, office or agency within WMATA or outside WMATA that the employee or independent contractor reasonably believes has the authority to act on the matter.
- (b) The Contractor, its employees, independent contractors and subcontractors shall cooperate with any inquiry or review by an authorized official of WMATA, or by the Federal government or any other governmental entity with jurisdiction over WMATA, regarding a matter that would constitute a report under paragraph (a) or a violation of

this or any whistleblower provision of this Contract, and with any enforcement or judicial proceeding arising from such inquiry or review.

- (c) The Contractor and its subcontractors shall not interfere with or deny the right of any employee or independent contractor of either the Contractor or any of its subcontractors to make a report under paragraph (a). The Contractor and its subcontractors shall not recommend, take or threaten to take any action having a negative or adverse impact on any employee or independent contractor of either the Contractor or any of its subcontractors because he or she:
 - (1) Made or is perceived to have made a report under paragraph (a);
 - (2) Sought a remedy under applicable law after making a report under paragraph (a);
 - (3) Participated in or cooperated with an inquiry or review by an authorized official of WMATA, or by the Federal government or any other governmental entity with jurisdiction over WMATA, regarding a matter that would constitute a report under paragraph (a) or a violation of this or any whistleblower provision of this Contract, or with an enforcement or judicial proceeding arising from such inquiry or review;
 - (4) Refused to obey an order that would violate law; or
 - (5) Refused to work or authorize work when a hazardous safety or security condition presents an imminent danger of death or serious injury, there was no reasonable alternative to refusal, there was not sufficient time to eliminate the danger in absence of refusal and the individual, where possible, notified the Contractor or subcontractor of the condition and of his or her intent not to perform or authorize work.

- (d) The Contractor shall include, or shall cause to be included, the substance of this clause, including this paragraph (d), in its subcontracts at all tiers.

- (e) The Contractor and its subcontractors shall comply with the National Transit Systems Security Act (NTSSA) 6 U.S.C. §1142, which prohibits discharging, demoting, suspending, reprimanding or in any other way discriminating against an employee as a reprisal for the employee lawfully and in good faith:
 - (1) Reporting a hazardous safety or security condition;
 - (2) Refusing to work when a hazardous safety or security condition presents an imminent danger of death or serious injury, there is no reasonable alternative to refusal, there is not sufficient time to eliminate the danger in absence of refusal and the individual, where possible, has notified the Contractor or subcontractor of the condition and of his or her intent to not perform work;
 - (3) Refusing to authorize the use of any safety or security related equipment, track or structures, if the individual is responsible for their inspection or repair and reasonably believes they are in a hazardous safety or security condition, there is no reasonable alternative to refusal, there is not sufficient time to eliminate the danger in absence of refusal and the individual, where possible, has notified the Contractor or subcontractor of the condition and of his or her

intent not to authorize use of hazardous equipment or infrastructure unless corrected;

- (4) Providing information for or directly assisting in an investigation of conduct that the individual reasonably believes to be in violation of Federal law regarding safety, security or fraud, waste or abuse of funds intended for safety or security;
 - (5) Refusing to violate or assist in violation of Federal public transportation safety or security law;
 - (6) Cooperating with a safety or security investigation by the U.S. Secretary of Transportation, U.S. Secretary of Homeland Security or the National Transportation Safety Board;
 - (7) Furnishing information to law enforcement agencies relating to an accident or incident resulting in damage to property, injury or death; or
 - (8) Filing a complaint under the NTSSA (6 U.S.C. §1142), or testifying regarding such complaint.
- (f) The Contractor shall notify the Authority of any instance, related to this Contract, of a report under subparagraph (e)(1) or refusal under subparagraphs (e)(2), (3) or (5).
- (g) The enforcement, filing and investigation of complaints, and remedies under this clause shall be governed by the NTSSA (6 U.S.C. §1142), applicable Federal regulations and Federal law.
- (h) This clause shall be interpreted in accordance with the NTSSA (6 U.S.C. §1142). If any provision is found to be in conflict with the NTSSA, the NTSSA shall govern.
- (h) The Contractor shall include, or shall cause to be included, this clause, including this paragraph, in its subcontracts at all tiers.

16. WORKPLACE VIOLENCE/ZERO TOLERANCE

Pursuant to Metro Policy/Instruction 7.8.3, all Metro Contractors must: (1) establish zero tolerance for acts of workplace violence for their employees and those of subcontractors at any tier, and (2) not retaliate against any of their employees or independent contractors for cooperating with investigations.

17. DRUG AND ALCOHOL TESTING (FOR SAFETY SENSITIVE FUNCTIONS ONLY) – FTA

- (a) Contractors who perform safety sensitive functions shall be subject to compliance with a drug and alcohol testing program according to Federal guidelines published in FTA regulations. The Contractor agrees to establish and implement a drug and alcohol testing program that complies with 49 C.F.R. Parts 40 and 655, produce any documentation necessary to establish its compliance with these regulations, and permit any authorized representative of the U.S. Department of Transportation or its operating administrations, applicable state oversight agency, or the Authority to

inspect the facilities and records associated with the implementation of the drug and alcohol testing program as required under 49 C.F.R. Part 655 and review the testing process. The Contractor further agrees as follows:

- (b) To certify its compliance with 49 C.F.R. Parts 40 and 655 and to submit a Management Information System (MIS) report, as required by Federal regulations, to WMATA's Medical Compliance Monitor (MCM) and the Contracting Officer before February 15th of each year. To certify compliance, the Contractor shall use the "Alcohol and Controlled Substances Testing" certification contained in the "Annual List of Certifications and Assurances for Federal Transit Administration Grants and Cooperative Agreements," that is published annually in the Federal Register.
- (c) To submit to the MCM and the Contracting Officer before February 15th of each year, a copy of the policy statement developed to implement its drug and alcohol testing program.
- (d) To provide to the MCM and the Contracting Officer before February 15th of each year the following:
 - (1) Employee and supervisor training documentation;
 - (2) The name and location of the collection site(s), laboratory(ies), Medical Review Officer(s), Breath Alcohol Technician(s), Collector(s), and Substance Abuse Professional(s); and a description of their random selection drug and alcohol testing process.
- (e) The Contractor further agrees to submit quarterly management reports summarizing test results to the MCM and the Contracting Officer by the 15th of the month following the end of each quarter.
- (f) Contractors are required to flow this clause down to all of their safety sensitive subcontractors and agents.

18. EMPLOYMENT RESTRICTION WARRANTY

- (a) The Contractor warrants that it will not offer employment to, solicit or discuss prospective employment with, or otherwise engage in substantive employment related discussions or communications with, any present or former Board member of the Authority who has been involved, directly or indirectly, in any matter of financial interest to the Contractor until at least two (2) years after the Board member has ceased involvement in the matter. The post-employment restriction on former Authority employees is one (1) year from the date of their last employment with WMATA. The Contractor shall not knowingly engage in communications of the nature described above with any immediate family member or member of the household of any Authority employee or Board member during the period when such employee or Board member is involved in any matter of financial interest to the Contractor.
- (b) If a former Board member or employee of the Authority is eventually hired, the Contractor shall ensure that the former Board member or employee is not involved in negotiating or otherwise dealing with the Authority on any particular matter over which he or she had responsibility during his or her tenure.

- (c) Should the Contractor fail to comply with the provisions hereof, and no fraud is suspected, the Contracting Officer shall have the right to withhold payment under this Contract in an amount not to exceed two percent (2%) of the total Contract amount as liquidated damages to the Authority, such withholding to be in addition to any other withholding or retainage under this Contract. Any dispute shall be settled in accordance with the "Disputes" clause of this Contract.
- (d) If fraud is suspected, the Authority's only remedy prior to a final decision by a court of competent jurisdiction is to report the matter to WMATA's Office of Inspector General (OIG), the U.S. Department of Transportation's Office of Inspector General (DOT-OIG), the Offices of Inspectors General of any state or Federal agency providing funding under this Contract and/or appropriate Federal, state and/or local law enforcement authorities.

19. GRATUITIES

- (a) In connection with performance of this Contract, or any changes or modifications relative thereto, the giving of or offering to give gratuities (in the form of entertainment, gifts or otherwise) by the Contractor, or any agent, representative or other person deemed to be acting on behalf of the Contractor, or any supplier or subcontractor furnishing material to or performing work under this Contract, to any Board member, employee or agent of the Authority; with a view toward securing this Contract or securing favorable treatment regarding this Contract is expressly forbidden. The terms of this "Gratuities" clause shall be strictly construed and enforced in the event of violations hereof.
- (b) Reported instances of the giving or offering to give gratuities within the context of this "Gratuities" clause will be investigated by the Authority's Board of Directors or its duly authorized representative. A preliminary investigation will be made to determine whether there is probable cause to suspect that a violation of this clause exists. If such probable cause exists, the Board of Directors, or its duly authorized representative, shall formally notify WMATA's Office of Inspector General (OIG), the U.S. Department of Transportation's Office of Inspector General (DOT-OIG), the Offices of Inspectors General of any state or Federal agency providing funding under this Contract and/or appropriate Federal, state and/or local law enforcement authorities.
- (c) The rights and remedies of the Authority provided in this clause shall not be exclusive and are in addition to any other rights and remedies provided under this Contract, at law or in equity.

20. OFFICIALS NOT TO BENEFIT

- (a) No member of or delegate to Congress, resident commissioner or member of a state or local public body shall be admitted to any share or part of this Contract, or to any benefit that may arise therefrom during his or her tenure or for two (2) years thereafter, unless his or her interest in the business entity that is awarded this Contract is placed in a blind trust in accordance with the rules and regulations of the U.S. Office of Government Ethics (OGE).

- (b) Enforcement of this clause shall be consistent with 18 U.S.C. §431.

21. ORGANIZATIONAL CONFLICTS OF INTEREST

- (a) An organizational conflict of interest (OCI) exists when the nature of the work to be performed under a proposed contract or a subcontract may, without some restriction on future activities result in an unfair competitive advantage to the Contractor or subcontractor; because of (1) unequal access to information, (2) biased ground rules or (3) impaired objectivity. An unequal access to information OCI may exist if in performing a Contract, a Contractor obtains access to non-public information that provides it with a competitive advantage in a later competition. A biased ground rules OCI may exist if the Contractor has a role in setting rules for a source selection in which it will compete. An impaired objectivity OCI may exist if, in performing a Contract, a Contractor is called upon to evaluate an offer from or performance by, itself or an affiliated entity.
- (b) In the event that the Contractor believes that it or any of its potential subcontractors may have an OCI, it shall notify the Contracting Officer, in writing, within five (5) working days after it becomes aware of the potential or actual OCI. The written notification shall identify the nature and circumstances of the perceived conflict and propose appropriate measures to eliminate or mitigate the OCI. The Contracting Officer will review the circumstances and the proposed mitigation plan and notify the Contractor stating whether: (1) no mitigation is required; (2) the conflict cannot be mitigated; or (3) the conflict can be mitigated and he or she accepts the proposed measures, or recommends additional measures.
- (c) The Contractor's failure to identify such perceived conflicts may result in the Contract being rescinded or terminated.
- (d) Should the Contractor identify or become aware of a conflict during the term of this Contract, including any extension thereof that it could not reasonably anticipate prior to award, it shall notify the Contracting Officer in accordance with paragraph (b), or request an exception to the restriction with supporting rationale. The Contracting Officer shall consider the Contractor's proposed measures to mitigate or eliminate the conflict, or the request for an exception.
- (e) If the proposed measures are not determined to be feasible or are otherwise not acceptable to the Contracting Officer, he or she may terminate the Contract. If the Contracting Officer does not grant a request for an exception, and the Contract is not terminated, the Contractor shall be notified in writing and be given ten (10) days from the date of the written notification to take all necessary actions to comply with this clause.
- (f) If the proposed measures are determined to be acceptable to the Contracting Officer, he or she may grant a specific exception to this restriction, when in the Contracting Officer's judgment, the exception will not create a conflict between the Contractor's duties and obligations under this Contract and the duties and obligations imposed on the Contractor under another contractual or other relationship.
- (g) If the Contractor fails to comply with the terms of this clause, and no fraud is suspected, the Contracting Officer, may withhold payments due under this Contract

until such time as the Contractor is in compliance or, should the non-compliance remain uncorrected at the expiration of ten (10) days from the Contracting Officer's written notice as provided in paragraph (b), terminate the contract for default pursuant to this Contract.

- (h) If fraud is suspected, the Authority's only remedy prior to a final determination by a court of competent jurisdiction is to report the matter to WMATA's Office of Inspector General (OIG), the U.S. Department of Transportation's Office of Inspector General (DOT-OIG), the Offices of Inspectors General of any state or Federal agency providing funding under this Contract and/or appropriate Federal, state and/or local law enforcement authorities.
- (i) The Contractor, in performing this Contract, shall avoid any conduct that might result in or give the appearance of creating for Board members or employees of the Authority in their relationship with the Contractor, any conflicts of interest or favoritism and/or the appearance thereof and shall avoid any conduct that might result in a Board member, or employee failing to adhere to any Code of Ethics or standards of conduct adopted by the Authority's Board of Directors.
- (j) The Contracting Officer's determination under this clause shall be final and shall be considered a question of fact within the meaning of the "Disputes" article of this Contract.

22. CONTRACTOR PERSONNEL

- (a) The Authority may direct the replacement of the Contractor's employees reasonably deemed to be unsuitable by the Contracting Officer, or whose continued participation in the work is deemed contrary to the best interests of the Authority. Except in circumstances deemed exigent by the Contracting Officer, the reason for replacement will be discussed between the Contractor and the Authority before a replacement directive is issued. Upon receipt of a written replacement directive from the Authority specifying the date by which the replacement must occur, the Contractor shall proceed with the replacement and shall do so in a manner that minimizes, to the greatest extent practicable, any impact upon the Contract.
- (b) Contractor personnel required to work on WMATA's property must obtain a WMATA vendors' badge and successfully complete the mandatory safety training that must be renewed yearly. The Contractor must advise its affected personnel that, to obtain a vendor's badge, a signed waiver to perform a background check is required.

23. FALSE STATEMENTS, CLAIMS OR SUBMISSIONS

- (a) The Contractor acknowledges its responsibility to undertake its obligations under this publicly funded Contract with full integrity and, to take all reasonable steps to ensure that statements, claims and submissions made pursuant to this Contract are provided in good faith and with a reasonable belief as to their truthfulness, accuracy and completeness.
- (b) In the event that it is finally determined by a court of competent jurisdiction that any statement, claim, submission, or certification made by or on behalf of the Contractor

pursuant to a material element of the Contract was knowingly false, fictitious or fraudulent, the Authority shall be entitled to recover from the Contractor, an amount equal to not more than three (3) times the monetary value of the benefit derived or sought to be derived by the Contractor through its false statement, claim or submission. For purposes hereof, an element of the Contract shall be deemed material if it impacted or could reasonably have been intended to impact the disposition of any claim, dispute, proposed or implemented change order, proposed pricing or schedule adjustment of any nature, or other substantive issue directly affecting the rights of the parties under the Contract.

- (c) The Authority's only remedy prior to a final determination by a court of competent jurisdiction is to report the matter to WMATA's Office of Inspector General (OIG), the U.S. Department of Transportation's Office of Inspector General (DOT-OIG), the Offices of Inspectors General of any state or Federal agency providing funding under this Contract and/or appropriate Federal, state and/or local law enforcement authorities.

- (d) The Authority's rights set forth in this article are in addition to any contractual, legal or equitable rights that may arise upon the Contractor's submission of a false claim or statement, including without limitation, the Authority's right to terminate the Contract for default once fraud is finally determined by a court of competent jurisdiction. The provisions of this clause shall not serve in any respect to limit, waive or modify any civil or criminal liability, of the Contractor or any of its officers, agents or employees that such conduct may precipitate.

CHAPTER X – MISCELLANEOUS ADDITIONAL PROVISIONS

1. FEDERAL, STATE, AND LOCAL TAXES

- (a) Except as may be otherwise provided in this Contract, the Contract price shall be deemed to include all applicable Federal, state and local taxes and duties.
- (b) If a statute, court decision, written ruling or regulation regarding any Federal excise tax or duty on the transactions or property covered by this Contract takes effect after the Contract date, and:
- (c) Results in the Contractor being required to pay or bear the burden of any such Federal excise tax or duty or rate increase that would not otherwise have been payable on such transactions or property, the Contract price shall be increased by the amount of such tax or duty or rate increase, if the Contractor warrants in writing that no amount for such newly imposed Federal obligation was included in the Contract price as a contingency reserve or otherwise; or
- (d) Results in the Contractor not being required to pay or bear the burden of, or in its obtaining a refund or drawback of, any Federal excise tax or duty that would otherwise have been payable on such transactions or property or that was the basis of an increase in the Contract price, the Contract price shall be decreased by the amount of the relief, refund, or drawback, or that amount shall be paid to the Authority, as the Contracting Officer directs. If the Contractor fails to follow the Contracting Officer's instructions, it will be required to pay or bear the burden of, any such Federal excise tax or duty through a decrease in the Contract price.
- (e) Paragraph (b) above shall not be applicable to social security taxes or to any other employment tax.
- (f) No adjustment of less than \$250 shall be made in the Contract price pursuant to paragraph (b).
- (g) As used in paragraph (b), the term "Contract date" means the date the Contract was executed by the Authority. As to additional services, supplies or construction procured by modification to this Contract, the term "Contract date" means the effective date of such modification.
- (h) The Contractor shall promptly notify the Contracting Officer of matters that may result in either an increase or decrease in the Contract price under this clause and shall take action as the Contracting Officer directs. The Authority shall be entitled to a reduction in the Contract price reflecting such amount and a refund of monies paid related to such taxes, plus applicable interest.

2. PUBLIC COMMUNICATION

The Contractor shall not issue communications to the media, place advertisements, nor publicize through any means the services, goods or construction that it is providing to WMATA under this Contract, without prior written consent of the Contracting Officer. The Contractor shall not publish, in print or online, any communications products such as

newsletters, press releases, blogs or other communications without the Contracting Officer's prior, written consent. Approval of any such requests shall be at the Contracting Officer's sole discretion.

3. CHOICE OF LAW, CONSENT TO JURISDICTION AND VENUE

- (a) This Contract shall be deemed to be executed in the District of Columbia, regardless of the domicile of the Contractor and shall be governed by and construed in accordance with the laws of the District of Columbia except to the extent, if any, superseded by Federal law.
- (b) The parties agree that any and all claims asserted by or against the Authority arising hereunder or related hereto shall be heard and determined either in the courts of the United States located in the District of Columbia, the State of Maryland or the Commonwealth of Virginia or in the courts of the District of Columbia, State of Maryland or Commonwealth of Virginia that maintain jurisdiction over such claims and where venue properly resides.

4. SEVERABILITY

If the Contract contains any unlawful provisions, the same shall be deemed of no effect, and shall upon the application of either party be stricken from the Contract without affecting the binding force of the Contract as it shall remain after omitting such provision.

5. SURVIVAL

Any provision expressly set forth as surviving the expiration or termination of this Contract, shall be deemed to survive any such expiration or termination.

CHAPTER XI – ADDITIONAL FEDERAL PROVISIONS

1. NOTIFICATION OF FEDERAL PARTICIPATION- FTA

This project is being funded in whole or part with Federal funds.

2. ALL NECESSARY FEDERAL PROVISIONS DEEMED INCLUDED- FTA

It is the intent of the parties that each and every provision of law required to be inserted in this Contract should be and is hereby inserted herein.

3. ACCESS TO THIRD PARTY CONTRACT RECORDS- FTA

(a) The Contractor agrees to provide the Authority, the FTA Administrator, the U.S. Comptroller General or any of their authorized representatives, access to any of the Contractor's books, documents, papers and records that are directly pertinent to this Contract for the purposes of making audits, examinations, excerpts and transcriptions. The Contractor also agrees, pursuant to 49 C.F.R. §633.17 to provide FTA Administrator or his or her authorized representatives including any Project Management Oversight (PMO) Contractor access to Contractor's records and construction sites pertaining to a major capital project, defined at 49 U. S. C. § 5302(a)(1), which is receiving Federal financial assistance through the programs described at 49 U. S. C. §§ 5307, 5309 or 5311.

(b) The Contractor agrees to permit any of the foregoing parties to reproduce by any means whatsoever or to copy excerpts and transcriptions as reasonably needed.

(c) The Contractor agrees to maintain all books, records, accounts and reports required under this Contract for a period of not less than three (3) years after the date of termination or expiration of this Contract. In the event of litigation or settlement of claims arising from the performance of this Contract, the Contractor agrees to maintain such records until the Authority, the FTA Administrator, the U.S. Comptroller General, or any of their duly authorized representatives, have disposed of all such litigation, appeals, claims or exceptions related thereto. [See 49 C.F.R. § 18.39(i)(11)].

4. AMERICANS WITH DISABILITIES ACT ACCESSIBILITY – FTA

(a) The Contractor agrees that it will operate public transportation services in compliance with 42 U.S.C. § 12101 *et seq.*; DOT regulations, "Transportation Services for Individuals with Disabilities (ADA)" using facilities and equipment that comply with 49 C.F.R. Part 37; and Joint ATBCB/DOT regulations, "Americans with Disabilities (ADA) Accessibility Specifications for Transportation Vehicles," 36 C.F.R. Part 1192 and 49 C.F.R. Part 38. Private entities must comply with the requirements of 49 C.F.R. Part 37 applicable to public entities with which they contract to provide public transportation services.

(b) Facilities to be used in public transportation service must comply with 42 U.S.C. § 12101 *et seq.*; DOT regulations, "Transportation Services for Individuals with Disabilities (ADA)," 49 C.F.R. Part 37; and Joint ATBCB/DOT regulations,

“Americans with Disabilities (ADA) Accessibility Specifications for Transportation Vehicles,” 36 C.F.R. Part 1192 and 49 C.F.R. Part 38.

5. RIGHTS IN DATA AND COPYRIGHTS — FTA

- (a) The term "subject data" used in this article means recorded information, whether or not copyrighted, that is delivered or specified to be delivered under this Contract. The term includes graphic or pictorial delineation in media such as drawings or photographs; text in specifications or related performance or design-type documents; machine forms such as magnetic tape, or computer memory printouts; and information retained in computer memory. Examples include, but are not limited to: computer software, engineering drawings and associated lists; specifications, standards, process sheets, manuals, technical reports, catalog item identifications, and related information. The term "subject data" does not include financial reports, cost analyses, and similar information incidental to Contract administration.

- (b) The following restrictions apply to all subject data first produced in the performance of this contract:
 - (1) Except for its or WMATA's own internal use, the Contractor may not publish or reproduce subject data in whole or in part, or in any manner or form, nor may the Contractor authorize others to do so, without the written consent of the U.S. Government, until such time as the Government may have either released or approved the release of such data to the public. This restriction on publication, does not apply to agreements with academic institutions;

 - (2) In accordance with 49 C.F.R. § 18.34 and 49 C.F.R. § 19.36, the Federal Government reserves a royalty-free, non-exclusive and irrevocable license to reproduce, publish, or otherwise use, and to authorize others to use, the following subject data for its purposes:
 - (i) Any subject data developed under this contract whether or not a copyright has been obtained; and

 - (ii) Any rights of copyright to which the contractor purchases ownership with Federal assistance.

- (c) When the Federal Transit Administration (FTA) provides financial assistance for a planning, research, development, or a demonstration project, it is FTA's general intention to increase mass transportation knowledge, rather than limit the benefits to participants in the project. Therefore, unless FTA determines otherwise, the Contractor agrees that, in addition to the rights set forth in subsection (b)(2) of this article, FTA may make available to any FTA recipient, sub-recipient, third party contractor, or third party subcontractor, either FTA's license in the copyright to the subject data derived under this Contract or a copy of the subject data first produced under this Contract. If this Contract is not completed for any reason whatsoever, all data developed under this Contract shall become subject data as defined in subsection (a) and shall be delivered as the Federal Government may direct.

- (d) Unless prohibited by state law, the Contractor agrees to indemnify, save, and hold harmless WMATA and the Federal Government, their officers, agents, and employees acting within the scope of their official duties against any liability,

including costs and expenses, resulting from the Contractor's willful or intentional violation of proprietary rights, copyrights, or right of privacy, arising out of the publication, translation, reproduction, delivery, use, or disposition of any data furnished under this Contract. The Contractor shall not be required to indemnify WMATA and the Federal Government for any such liability arising out of the wrongful acts of their employees or agents.

- (e) Nothing contained in this article shall imply a license to WMATA or the Federal Government under any patent or be construed as affecting the scope of any license or other right otherwise granted to WMATA or the Federal Government under any patent.
- (f) The requirements of paragraphs (b) and (c), do not apply to material furnished by the Authority to the Contractor and incorporated in the work carried out under the contract provided that the Contractor identifies the incorporated material at the time of delivery of the work.
- (g) Any dispute arising under this article shall be subject to the "Disputes" article of this Contract.
- (h) Notwithstanding any other payment provision in this Contract, the Contracting Officer may retain from payments due and owing the Contractor up to 10 percent (10 %) of the contract price until final delivery and acceptance of the subject data defined in this article and as required to be furnished by the Price Schedule or the Contract's specifications.

6. PATENT RIGHTS- FTA

- (a) Depending on the nature of the project, the Federal Government may acquire patent rights when the Contractor produces a patented or patentable invention, improvement or discovery. The Federal Government's rights arise when the patent or patentable information is conceived, or first reduced to practice. When a patent is issued or patentable information becomes available, the Contractor will report the same to the Authority, to enable it to notify FTA and provide a detailed report satisfactory to FTA.
- (b) Unless the Federal Government determines otherwise in writing, regardless of the status of any contractor, WMATA will transmit the Federal Government's patent rights to FTA as specified in 35 U.S.C. § 200, *et. seq.* and the Department of Commerce's regulations "Rights to Inventions Made by Nonprofit Organizations and Small Business Firms under Government Grants, Contracts, and Cooperative Agreements," 37 C.F.R. Part 401.

7. BUY AMERICA ACT- FTA

- (a) The Buy America Act requirements apply to the following types of contracts: construction contracts, the acquisition of goods or rolling stock valued at more than \$150,000.00³

³ If the federal grant that funds this procurement was issued prior to 12/2014, then this amount is \$100,000.00.

- (b) The Contractor agrees to comply with 49 U.S.C. § 5323(j) and 49 C.F.R. Part 661, which provide that Federal funds may not be obligated unless steel, iron, and manufactured products used in FTA funded projects are produced in the United States, unless a waiver has been granted by FTA or the product is subject to a general waiver. General waivers are listed in 49 C.F.R. § 661.7, and include final assembly in the United States for fifteen (15) passenger vans and fifteen (15) passenger wagons produced by the Chrysler Corporation, and microcomputer equipment and software. Separate requirements for rolling stock are set out at 49 U.S.C. § 5323(j)(2)(C) and 49 C.F.R. § 661.11. Rolling stock must be assembled in the United States and have a sixty-five percent (65%) domestic content.
- (c) Contractor is responsible for flowing down these requirements to subcontractors at every tier. The dollar threshold only applies to the prime contract. All subcontracts thereunder are subject to the Buy America Act requirements.
- (d) A bidder must submit to WMATA the appropriate Buy America Act certification with all offers on FTA funded contracts, except those subject to a general waiver. Bids that are not accompanied by the appropriate Buy America Act certification must be rejected as nonresponsive. This requirement does not apply to lower tier subcontractors.

8. PRE-AWARD AND POST DELIVERY AUDIT REQUIREMENTS – FTA

The Contractor agrees to comply with 49 U.S.C. § 5323(l) and FTA's implementing regulations at 49 C.F.R. Part 663 and to submit the following certifications:

- (a) *Buy America Act Requirements.* The Contractor shall complete and submit a declaration certifying either compliance or noncompliance with the Buy America Act. If the offeror certifies compliance with the Buy America Act, it shall submit documentation that lists 1) component and subcomponent parts of the rolling stock to be purchased identified by manufacturer of the parts, their country of origin and cost; and 2) the location of the final assembly point for the rolling stock, including a description of the activities that will take place at the final assembly point and the cost of final assembly.
- (b) *Solicitation Specification Requirements:* The Contractor shall submit evidence that it will be capable of meeting the proposed specifications.
- (c) *Federal Motor Vehicle Safety Standards (FMVSS):* The Contractor shall submit 1) manufacturer's FMVSS self-certification sticker information that the vehicle complies with relevant FMVSS or 2) manufacturer's certified statement that the contracted vehicles will not be subject to FMVSS regulations.

9. CHARTER BUS REQUIREMENTS- FTA

Not Applicable

10. SCHOOL BUS REQUIREMENTS- FTA

- (a) Not Applicable

11. BUS TESTING- FTA

Not Applicable

12. CARGO PREFERENCE- FTA

The Contractor agrees:

- (a) To utilize privately owned United States flag commercial vessels to ship at least fifty percent (50%) of the gross tonnage (computed separately for dry bulk carriers, dry cargo liners, and tankers) involved, whenever shipping any equipment, materials, or commodities pursuant to this Contract if such vessels are available at fair and reasonable rates for United States flag commercial vessels;
- (b) To furnish within twenty (20) working days following the date of loading for shipments originating within the United States, or within thirty (30) working days following the date of loading for shipments originating outside the United States, a legible copy of a rated, "on-board" commercial ocean bill-of-lading in English for each shipment of cargo described in paragraph (a) above to WMATA (through the Contractor in the case of a subcontractor's bills-of-lading) and to the Office of Cargo Preference, Maritime Administration (MAR-590), 400 Seventh Street SW, Washington, DC 20590;
- (c) To include these requirements in all subcontracts issued pursuant to this Contract when the subcontract may involve the transport of equipment, material, or commodities by ocean liner.

13. CLEAN AIR ACT- FTA

- (a) The Contractor agrees to comply with all applicable standards, orders or regulations issued pursuant to the Clean Air Act, as amended, 42 U.S.C. §§ 7401-7671. The Contractor agrees to report each violation to the Authority and understands and agrees that the Authority will, in turn, report each violation as required to FTA and the appropriate EPA Regional Office.
- (b) The Contractor will comply with U.S. EPA Regulations "Control of Air Pollution from Mobile Sources," 40 C.F.R. Part 85; "Control of Emissions from New and In-Use Highway Vehicles and Engines," 40 C.F.R. Part 86; "Fuel Economy and Greenhouse Gas Exhaust Emissions of Motor Vehicles," 40 C.F.R. Part 600, as well as any applicable State Implementation Plans (SIP), and EPA regulations "Conformity to State or Federal Implementation Plans of Transportation Plans, Programs and Projects Developed, Funded or Approved Under Title 23 U.S.C. or Federal Transit Laws" 40 C.F.R. Part 93, along with other applicable Federal regulations.
- (c) Flow-down requirement. The Contractor also agrees to include this article in each subcontract exceeding \$150,000 financed, in whole or in part, with Federal assistance provided by FTA.

14. CLEAN WATER ACT- FTA

- (a) The Contractor agrees to comply with all applicable standards, orders or regulations issued pursuant to the Clean Water Act, as amended, 33 U.S.C. §§1251-1377. The Contractor agrees to report each violation to the Authority and understands and agrees that the Authority will, in turn, report each violation as required to assure notification to FTA and the appropriate EPA Regional Office.
- (b) The Contractor will protect underground sources of drinking water in compliance with the Safe Drinking Water Act of 1974, as amended, 42 U.S.C. §§300 (f)-(j).
- (c) The Contractor will comply with the notice of violating facility provisions in section 508 of the Clean Water Act, as amended, 33 U.S.C. § 1368.
- (d) The Contractor will facilitate compliance with Executive Order 11738, "Providing for Administration of the Clean Air Act and the Federal Water Pollution Control Act with Respect to Federal Contracts, Grants or Loans," 42 U.S.C. §7606 note.
- (e) Flow-down requirement. The Contractor also agrees to include this clause in each subcontract exceeding \$150,000 financed, in whole or in part, with Federal assistance provided by FTA.

15. RECOVERED MATERIALS/ RECYCLED PRODUCTS- FTA

- (a) The Contractor agrees to comply with all the requirements of Section 6002 of the Resource Conservation and Recovery Act (RCRA), as amended (42 U.S.C. § 6962), including but not limited to the regulatory provisions of 40 C.F.R. Part 247, and Executive Order 12873, as they apply to the procurement of the items designated in Subpart B of 40 CFR Part 247.
- (b) Flow-down requirement. The Contractor also agrees to include these requirements in each subcontract financed, in whole or in part, with Federal assistance provided by FTA.

16. RETAINAGE

- (a) *Not Applicable*
- (b) *Final Payment Only Retainage.* All amounts withheld from Contractor as retainage, based on a percentage of the work completed, or as a line item tied to the completion of the work shall be retained solely out of the Contractor's final payment. Payment of any fund withheld from Contractor's final payment shall be released to Contractor within thirty (30) days after completion of Contractor's Work and Closeout Release.
- (c) *Not Applicable*

17. ENERGY CONSERVATION- FTA

- (a) The Contractor agrees to comply with mandatory standards and policies relating to the energy efficiency which are contained in the applicable state energy conservation plan issued in compliance with the National Energy Policy and Conservation Act, as amended, 42 U.S.C. § 6321, *et. seq.*
- (b) The Contractor agrees to perform an energy assessment for any building constructed, reconstructed or modified with FTA funds as required under FTA regulations, "Requirements for Energy Assessments." 49 C.F.R. Part 622.
- (c) The Contractor must include this clause in all subcontracts and sub-agreements at every tier.

18. CHANGES TO FEDERAL REQUIREMENTS- FTA

- (a) Contractor shall at all times comply with all applicable FTA regulations, policies, procedures and directives, including without limitation those listed directly or by reference in the Agreement (Form FTA MA (22) dated October 1, 2015) between the Authority and FTA, as they may be amended or promulgated during the term of this Contract. Contractor's failure to so comply shall constitute a material breach of this Contract.
- (b) Flow-down requirement. The Contractor agrees to include this Article in each subcontract financed in whole or in part with Federal Assistance provided by FTA. It is further agreed that the Article shall not be modified, except to identify the subcontractor who will be subject to its provisions.

19. FLY AMERICA REQUIREMENTS- FTA

- (a) The Contractor agrees to comply with 49 U. S. C. § 40118 (the "Fly America" Act) in accordance with the General Services Administration's regulations at 41 C.F.R. § 301-10, which provide that recipients and sub-recipients of Federal funds and their contractors are required to use U. S. Flag carriers for U. S. Government financed international air travel and transportation of their personal effects or property, to the extent such service is available, unless travel by foreign air carrier is a matter of necessity, as defined by the Fly America Act. If a foreign air carrier was used, the Contractor shall submit an appropriate certification or memorandum adequately explaining why service by a U. S. flag carrier was not available or why it was necessary to use a foreign air carrier and shall provide a certificate of compliance with the Fly America requirements.
- (b) Flow-down requirement. The Contractor agrees to include the requirements of this article in all subcontracts that may involve international air transportation.

20. PAYMENT DEDUCTIONS - NONCOMPLIANCE WITH DBE REQUIREMENTS- FTA

- (a) For Federally funded contracts that exceed \$150,000 and to which the Disadvantage Business Enterprise (DBE) Requirements (Appendix B) apply, the failure to perform in accordance with requirements of Appendix B may result in a partial or full suspension of payment, including progress payments, if applicable.

- (b) If the Contractor is found to be in noncompliance with the DBE requirements of Appendix B, the progress of the work shall also be deemed to be unsatisfactory, and an amount equal to the DBE participation in the Contract shall be retained from payment (or progress payments, if any) made to the Contractor.
- (c) If the contract value is over \$150,000, the prime contractor will be responsible for submitting a monthly report of the status of its DBE subcontractors as outlined in Appendix B to the Contracting Officer.
- (d) If the Contractor fails to submit the required monthly DBE reports, the Contracting Officer may suspend payment (or progress payments) until such time as the monthly reports are submitted and accepted by the Authority.

21. GOVERNMENT-WIDE DEBARMENT OR SUSPENSION- FTA

- (a) The Contractor is bound by its certification contained in its bid that neither the Contractor its principals, or affiliates, are excluded or disqualified, from Federal contracting. The certification is a material representation of fact, relied upon by the Authority in entering into this Contract. If it is later determined that the Contractor knowingly rendered an erroneous certification, in addition to remedies available to the Authority, the Federal Government may pursue available remedies, including but not limited to suspension and/or debarment. The Contractor agrees to comply with the requirements of 2 C.F.R, part 180, subpart C as adopted and supplemented by U.S. DOT regulations at 2 C.F.R, part 1200 “Nonprocurement Suspension and Debarment,” including any amendments thereto, Executive Orders Nos. 12549 and 12689 “Debarment and Suspension” 31 U.S.C. § 6101 note, and other applicable Federal laws, regulations or guidance regarding participation with debarred or suspended contractors throughout the term of this Contract.
- (b) Flow-down requirement. The Contractor agrees to include this article in all subcontracts at all tiers under this Contract requiring lower tier contractors to comply with Federal suspension and debarment requirements, and review the System for Award Management (SAM) at www.sam.gov in order to comply with U.S. DOT regulations at 2 C.F.R, Part 1200 prior to awarding any subcontract under this Contract.

22. INCORPORATION OF FEDERAL TRANSIT ADMINISTRATION (FTA) TERMS

- (a) The preceding provisions include, in part, certain standard terms and conditions required by the U.S. Department of Transportation (DOT), whether or not expressly set forth in other Contract provisions. All Contractual provisions required by DOT, as set forth in FTA Circular 4220.1F and FTA Master Agreement (23) October 1, 2016 or any revision thereto, are hereby incorporated by reference. Anything to the contrary herein notwithstanding, all DOT or FTA mandated terms shall be deemed to control in the event of a conflict with other provisions contained in this Contract. The Contractor shall not perform any act, fail to perform any act, or refuse to comply with any of the Authority’s requests that would cause the Authority to be in violation of the FTA terms and conditions.
- (b) Flow-down requirement. The Contractor agrees to include this clause in each subcontract financed in whole or in part with Federal assistance provided by FTA. It

is further agreed that the clause shall not be modified, except to identify the subcontractor who will be subject to the provisions.

23. NO FEDERAL GOVERNMENT OBLIGATIONS TO THIRD PARTIES- FTA

- (a) The Authority and the Contractor acknowledge and agree that, notwithstanding any concurrence by the Federal Government in or approval of the solicitation or award of this Contract, absent the express written consent by the Federal Government, it is not a party to this Contract and shall not be subject to any obligations or liabilities to the Authority, Contractor, or any other party (whether or not a party to that contract) pertaining to any matter resulting from this Contract.
- (b) Flow-down requirement. The Contractor agrees to include this clause in each subcontract financed in whole or in part with Federal assistance provided by FTA. It is further agreed that the clause shall not be modified, except to identify the subcontractor who will be subject to its provisions.

24. FALSE STATEMENTS OR CLAIMS CIVIL AND CRIMINAL FRAUD- FTA

- (a) The Contractor acknowledges that the provisions of the Program Fraud Civil Remedies Act of 1986, as amended, 31 U. S. C. § 3801 *e.t seq.* and U. S. DOT Regulations, "Program Fraud Civil Remedies," 49 C.F. R. Part 31, apply to its actions pertaining to this Contract. Upon execution of this Contract, the Contractor certifies and affirms the truthfulness and accuracy of any statement it has made, it makes, it may make, or causes to be made, pertaining to this Contract or FTA assisted project for which this Contract is being performed. In addition to other penalties that may be applicable, the Contractor further acknowledges that if it makes or causes to be made, a false, fictitious, or fraudulent claim, statement, submission, or certification, the Federal Government reserves the right to impose the penalties of the Program Fraud Civil Remedies Act of 1986 on the Contractor to the extent that it deems appropriate.
- (b) The Contractor also acknowledges that if it makes, or causes to be made, a false, fictitious, or fraudulent claim, statement, submission, or certification to the Federal Government under a contract connected with a project that is financed in whole or in part with Federal assistance originally awarded by FTA under the authority of 49 U. S. C. 5307, the Government reserves the right to impose the penalties of 18 U. S. C. 1001 and 49 U. S. C 5307 (n)(1) on the Contractor, to the extent the Federal Government deems appropriate.
- (c) Flow-down requirement. The Contractor agrees to include this clause in each subcontract financed in whole or in part with Federal assistance provided by FTA. It is further agreed that the clause shall not be modified, except to identify the subcontractor who will be subject to the provisions.

25. LOBBYING- FTA

- (a) The Contractor agrees that it will not use Federal funds to influence any officer or employee of a Federal agency, member of Congress or an employee of a member of Congress or an officer or employee of Congress on matters that involve this Contract or the underlying grant or agreement, including any award, extension or modification.

- (b) Contractor agrees that it will comply with 31 U.S.C. § 1352, as amended, U.S. DOT regulations "New Restrictions on Lobbying" 49 C.F.R, Part 20, to the extent consistent with 31 U.S.C. § 1352, as amended and other applicable Federal laws, regulations and guidance prohibiting the use of Federal funds for any activity concerning legislation or appropriations designed to influence the U.S. Congress or a state legislature unless an exception exists in current Federal law.
- (c) Flow-down requirement. The Contractor agrees to include these requirements in all subcontracts at all tiers under this Contract.

26. NATIONAL INTELLIGENT TRANSPORTATION SYSTEMS ARCHITECTURE AND STANDARDS-FTA

The Contractor agrees to:

- (a) Conform to the National Intelligent Transportation Systems (ITS) Architecture requirements of 23 U.S.C. § 517(d), as amended by MAP-21, unless it obtains an exemption from those requirements;
- (b) Follow:
 - (1) FTA Notice, "PTA National ITS Architecture Policy on Transit Projects," 66 Fed. Reg. 1455, January 8, 2001, and
 - (2) All other applicable Federal guidance, and
- (c) Flow this provision down to all applicable subcontracts.

27. CONTRACTS INVOLVING FEDERAL PRIVACY ACT REQUIREMENTS- FTA

The following requirements apply to the Contractor and its employees that administer any system of records on behalf of the Federal Government under any contract:

- (a) The Contractor agrees to comply with, and assures the compliance of its employees with, the information restrictions and other applicable requirements of the Privacy Act of 1974, 5 U.S.C. § 552 (a). Among other things, the Contractor agrees to obtain the express consent of the Federal Government before the Contractor or its employees operate a system of records on behalf of the Federal Government. The Contractor understands that the requirements of the Privacy Act, including the civil and criminal penalties for violation of that Act, apply to those individuals involved, and that failure to comply with the terms of the Privacy Act may result in termination of the underlying contract.
- (b) The Contractor also agrees to include these requirements in each subcontract involving the administration of any system of records on behalf of the Federal government financed, in whole or in part, with Federal assistance provided by FTA.

28. PROGRESS PAYMENTS

When satisfactory progress has not been achieved by a Contractor during any period for which a progress payment is to be made, a percentage of the progress payment may be

retained. Retainage should not be used as a substitute for good contract management, and the Contracting Officer should not withhold funds without cause. Determinations to retain and the specific amount to be withheld shall be made by the Contracting Officer on a case-by-case basis. Such decisions will be based on the Contracting Officer's assessment of past performance and the likelihood that such performance will continue. The amount of retainage withheld shall not exceed ten percent (10%) of the approved, estimated amount in accordance with the terms of this Contract and may be adjusted as the Contract approaches completion to recognize better than expected performance, the ability to rely on alternative safeguards, and other factors. Upon completion of all Contract requirements, retained amounts shall be paid promptly.

29. BONDING FOR CONSTRUCTION PROJECTS EXCEEDING \$150,000 – FTA

The Contractor agrees to comply with applicable bonding requirements as follows:

- (a) *Proposal Security.* A proposal bond must be issued by a fully qualified surety company acceptable to WMATA and listed as a company currently authorized under 31 C.F.R. Part 223 as possessing a Certificate of Authority as described thereunder.
- (b) *Rights Reserved.* In submitting its offer, it is understood and agreed by offeror that the right is reserved by WMATA to reject any and all offers, or part of any offer. It is also understood and agreed that if the offeror refuses or is unable to enter into this Contract, or refuses or is unable to furnish adequate and acceptable performance bonds and labor and material payments bonds, or refuses or is unable to furnish adequate and acceptable insurance, it shall forfeit its security to the extent of WMATA's damages occasioned by such withdrawal, or refusal, or inability to enter into an agreement, or provide adequate security therefore.

It is further understood and agreed that to the extent that the defaulting offeror's proposal bond, certified check, cashier's check, treasurer's check, and/or official bank check (excluding any income generated thereby that was retained by WMATA) shall prove inadequate to fully compensate WMATA for the damages occasioned by default, then the offeror agrees to indemnify WMATA and pay over to WMATA the difference between the proposal security and WMATA's total damages, so as to make WMATA whole.

- (c) *Performance and Payment Bonding Requirements (Construction).* The Contractor shall be required to obtain performance and payment bonds as follows:
 - (1) *Performance bonds.* The penal amount of performance bonds shall be one hundred percent (100%) of the original Contract price, unless WMATA determines that a lesser amount would be adequate for its protection.
 - (2) WMATA may require additional performance bond protection when the Contract price is increased. The increase in protection shall generally equal one hundred percent (100%) of the increase in Contract price. WMATA may secure additional protection by directing the Contractor to increase the penal amount of the existing bond or to obtain an additional bond.
- (d) *Payment bonds.* The penal amount of the payment bonds shall equal:
 - (1) Fifty percent (50%) of the Contract price, if it is not more than \$1,000,000.

- (2) Forty percent (40%) of the Contract price, if it is more than \$1,000,000, but not more than \$5,000,000; or
- (3) Two and one half million (\$2,500,000), if the Contract price is more than \$5,000,000.
- (d) If the original Contract price is \$5,000,000 or less, WMATA may require additional protection, if the Contract price is increased.

30. BONDING REQUIREMENTS- GENERAL

- (a) *Performance and Payment Bonding Requirements (Non-Construction).* The Contractor may, as a condition to the issuance of a Notice to Proceed, be required to obtain performance and payment bonds on forms acceptable to the Authority when necessary to protect the WMATA's interests. The following situations may warrant a performance bond:

- (1) WMATA's property or funds will be provided to the Contractor for use in performing the Contract or as partial compensation (as in retention of salvaged material).
- (2) If Contractor sells assets to or merges with another concern, and WMATA, after recognizing the latter concern as the successor in interest, desires assurance that it is financially capable.

Substantial progress payments will be made before the delivery of end items begins.

- (3) This Contract is for dismantling, demolition, or removal of improvements.
- (b) When it is determined that a performance bond is required, the Contractor shall be required to obtain performance bonds, as follows:

- (1) The penal amount of performance bonds shall be one hundred percent (100%) of the original Contract price, unless WMATA determines that a lesser amount would be adequate for its protection.
- (2) WMATA may require additional performance bond protection when the Contract price is increased. The increase in protection shall generally equal one hundred percent (100%) of the increase in Contract price. WMATA may secure additional protection by directing the Contractor to increase the penal amount of the existing bond or to obtain an additional bond.

- (c) A payment bond is required only when a performance bond is required, and if the use of payment bond is in WMATA's interests. When it is determined that a payment bond is required, the Contractor shall be required to obtain payment bonds as follows:

- (1) Fifty percent (50%) of the Contract price, if it is not more than \$1,000,000;

- (2) Forty percent (40%) of the Contract price, if it is more than \$1,000,000, but not more than \$5,000,000; or
 - (3) Two and one half million (\$2,500,000), if the Contract price is increased.
 - (d) *Advance Payment Bonding Requirements.* The Contractor may be required to obtain an advance payment bond, if the Contract contains an advance payment provision and a performance bond is not furnished. WMATA shall determine the amount of the advance payment bond necessary to protect it.
 - (e) *Patent Infringement Bonding Requirements (Patent Indemnity).* The Contractor may be required to obtain a patent indemnity bond, if a performance bond is not furnished and the financial responsibility of the Contractor is unknown or doubtful. WMATA shall determine the amount of the patent indemnity required to protect it.
 - (f) *Warranty of the Work and Maintenance Bonds.* The Contractor warrants to WMATA, the architect and/or engineer that all materials and equipment furnished under this Contract will be of highest quality and new, unless WMATA specifies otherwise, free from faults and defects and in conformance with the Contract. All work not conforming to these standards shall be considered defective. If required by the Project Manager, the Contractor shall furnish satisfactory evidence as to the kind and quality of materials and equipment.
- (1) The work furnished must be of first quality and the workmanship must be the best obtainable in the various trades. The work must be safe, substantial and durable in all respects. The Contractor hereby guarantees that the work will not contain defective materials or faulty workmanship for a minimum period of one (1) year after final payment by WMATA. The Contractor shall replace or repair any defective materials or equipment or faulty workmanship during the period of the guarantee at no cost to WMATA. As additional security for these guarantees, the Contractor shall, prior to the release of final payment, furnish separate maintenance (or guarantee) bonds in a form acceptable to WMATA written by the same corporate surety that provides the performance bond and labor and material payment bond for this Contract. These bonds shall secure the Contractor's obligation to replace or repair defective materials and faulty workmanship for a minimum period of one (1) year after final payment and shall be written in an amount equal to one hundred percent (100%) of the Contract amount, as adjusted.

31. SEISMIC SAFETY – FTA

The Contractor agrees that any new building or addition to an existing building will be designed and constructed in accordance with the standards for Seismic Safety required in Department of Transportation's Seismic Safety Regulations, 49 C.F.R. Part 41 and will certify compliance to the extent required by the regulation. The Contractor also agrees to ensure that all work performed under this Contract, including work performed by a subcontractor is in compliance with the standards required by the Seismic Safety Regulations and the certification of compliance issued on the project.

CHAPTER XII-WMATA POLICIES

1. SAFETY REQUIREMENTS

- (a) The Contractor shall be responsible for ensuring compliance with the most stringent provisions of the applicable statutes and regulations of the District of Columbia, State of Maryland, Commonwealth of Virginia or political subdivision where the work is being performed, as well as the METRO Construction Safety and Environmental Manual (1984, as amended) issued by the Authority, and the U.S. Department of Labor OSHA standards pertaining to the safe performance of the work. In the absence of a specific construction industry standard, the Contractor is required to comply with either an established OSHA General Industry Standard, National Institute for Occupational Safety and Health (NIOSH) guidelines, American Conference of Governmental Industrial Hygienists (ACGIH) guidelines, American National Standards Institute (ANSI) guidelines, the WMATA System Safety Program Plan, the WMATA Construction Safety and Environmental Manual, or the Metrorail Safety Rules and Procedures Handbook. For contracts where work will be performed on, or will interface with the Metrorail System, the Contractor shall also comply with the publication entitled "Metrorail Safety Rules and Procedures Handbook." In the event of a conflict between these guidelines and applicable Federal, State or local health and safety laws, regulations or standards, the more stringent standard shall apply. Further, the Contractor shall ensure that all methods of performing the work do not involve danger to the personnel working at the site, the public and private property, whether or not these methods are cited or indicated in the Contract. The Contractor shall immediately provide to the Contracting Officer, a copy of all citations and/or warnings of safety violations received from any Federal, State or local jurisdiction or agency thereof, and/or all notifications of safety violations from insurance companies. The Contractor shall also provide to the Contracting Officer, copies of any and all subpoenas, complaints or other documents relating to any law suit alleging safety violations.
- (b) The Contractor shall employ and assign a full-time Safety Superintendent for Contracts involving "safety sensitive" functions (See Combined Glossary attached hereto for a definition). The Safety Superintendent shall have a minimum of three (3) years of construction safety experience and hold an OSHA thirty (30) hour course card. He or she shall have the ability to develop and conduct safety training courses. He or she shall be familiar with industrial hygiene equipment and testing as required for the protection of all employees. The Safety Superintendent shall be employed exclusively for the purpose of supervising the safety of persons on or about the worksite and the property affected thereby. The Safety Superintendent shall also be responsible for providing first aid at the worksite and must have a current Red Cross First Aid Certificate. The Contractor shall notify the Contracting Officer a reasonable amount of time beforehand, any time that the Safety Superintendent will not be on site during work hours. If, at any time, the worksite is without the services of an approved Safety Superintendent for a period of three (3) calendar days or more, the work may be closed down at the Contracting Officer's discretion. The Safety Superintendent must be acceptable to the Contracting Officer and his or her performance will be reviewed on a continuing basis. If the Safety Superintendent's effectiveness is below standard, the Contractor shall provide immediate replacement at the Contracting Officer's direction. Once employed, the Safety Superintendent shall not be changed

without the Contracting Officer's permission. The Safety Superintendent can be terminated at any time, at the Contracting Officer's discretion.

- (c) The Contractor shall provide, at the site of the work, a first aid kit which shall be fully equipped to meet the needs of the anticipated work force.
- (d) The Contractor shall follow all appropriate RAIL Operational Rules, Operational Administrative Procedures (OAPs), Standard Operational Procedures (SOPs) and General and Special Orders while on the operational railroad and all Start-Up Rules and Manager's Notices when in declared start-up areas.

2. PRE-EMPLOYMENT CRIMINAL BACKGROUND CHECK REQUIREMENT

- (a) As a prerequisite to eligibility for a WMATA-issued identification and access badge ("One Badge"), access to WMATA's customers, property, or confidential information, and in consideration for this Contract, the Contractor shall have the sole responsibility for, and shall assure, adequate criminal background screenings on a routine basis of all of its personnel who are or will be working on WMATA's premises (whether they receive a One Badge or not) or otherwise have access to WMATA's customers, property, or confidential information.
- (b) Contractor shall implement, not later than notice to proceed, a criminal background check screening of the Contractor's personnel that shall take into consideration (1) the nature of the services or work being performed under the contract with particular regard for the individual's access to, and interaction with, WMATA's customers, property, and confidential information; (2) the nature or gravity of the offense or conduct resulting in a criminal conviction; and (3) the time that has lapsed since the conviction and/or completion of the sentence.
- (c) The Contractor shall contract with, or otherwise engage, a reputable third-party vendor to conduct the required criminal background screenings, and shall provide the vendor with a copy of its criminal background check screening policies and procedures.
- (d) The Contractor shall not place any person on or engage any person under this Contract, unless that person passes the Contractor's criminal background screening. At the end of each calendar quarter, the Contractor shall certify to the Contracting Officer's Technical Representative on a form provided, its compliance with this criminal background screening requirement and confirm that all persons required to be screened passed the contractor's criminal background screening before working on this Contract. For the sole purpose of monitoring the Contractor's compliance, WMATA reserves the right to request additional documents or perform its own criminal background screening of Contractor's personnel. The Contracting Officer will inform the Contractor, in writing, of any proposed action within a reasonable time before such action is taken.
- (e) The Contractor shall indemnify and hold WMATA harmless from any and all claims, demands, damages, costs and expenses, including attorneys' fees and other costs and expenses associated with any claims, demands, requests for relief, and/or other liabilities arising out of or resulting from the contractor's criminal background screening obligations and processes.

- (f) The Contractor will include this requirement in all subcontracts under this Contract, and receive certifications from their subcontractors to ensure that its subcontractors' personnel who are or will be working on WMATA's premises (whether they receive a One Badge or not) or otherwise have access to WMATA's customers, property, or confidential information undergo the required criminal background checks.

3. WORKPLACE VIOLENCE/ZERO TOLERANCE

Pursuant to Metro Policy/Instruction 7.8.3, all Metro Contractors and subcontractors at any tier must: (1) establish zero tolerance for acts of workplace violence for their employees and independent contractors, and (2) not retaliate against any of their employees or independent contractors for cooperating with investigations.



MID-ATLANTIC COOPERATIVE RIDER CLAUSE

The Mid-Atlantic Purchasing Team (MAPT) is the agreement between the Metropolitan Washington Council of Governments (“MWCOCG”) and the Baltimore Metropolitan Council (“BMC”) to aggregate the public entity and non-profit purchasing volumes in the Maryland, Virginia and Washington, D.C. region (“region”).

Format

A lead agency format is used to accomplish this work. The Lead Agency in this procurement has included this MAPT Cooperative Rider Clause in this solicitation indicating its willingness to allow other public entities to participate pursuant to the following Terms and Conditions:

1. Terms
 - 1.1 Participating entities, through their use of the Cooperative Rider Clause, agree to the terms and conditions of the resulting contract to the extent that they can be reasonably applied to the participating entity.
 - 1.2 Participating entities may also negotiate additional terms and conditions specific to their local requirements upon mutual agreement between the parties.
2. Other Conditions - Contract and Reporting
 - 2.1 The contract resulting from this solicitation shall be governed by and "construed in accordance with the laws of the State/jurisdiction in which the participating entity officially is located;
 - 2.2 To provide to MWCOCG and/or BMC contract usage reporting information, including but not limited to quantity, unit pricing and total volume of sales by entity, as well reporting other participating entities added on the contract, on demand and without further approval of contract participants;
 - 2.3 Contract obligations rest solely with the participating entities only;
 - 2.4 Significant changes in total contract value may result in further negotiations of contract pricing with the lead agency and participating entities.

In pricing and other conditions, vendors are urged to consider the broad reach and appeal of MAPT with public and non-profit entities in this region.

A list of the participating members of the Mid-Atlantic Purchasing Team can be found at the following web links www.mwcog.org/purchasing-and-bids/cooperative-purchasing/member-links/ and <http://www.baltometro.org/our-work/cooperative-purchasing/brcpc-representatives>

BOND FORMS

Not Applicable

TECHNICAL SPECIFICATIONS- SCOPE OF WORK

1. Introduction

The Washington Metropolitan Area Transit Authority (WMATA) is seeking to procure warehouse and rack shelving that include pallet racks, bulk racks, bar pipe and rod racks, and cantilever racks for the material handling storage in the new Dulles Railyard and Maintenance Facilities as specified below. Refer to Attachments A and B for layout plans indicating the warehouse and other rack shelving locations for each facility, and the exact count and description of the items.

2. Background

The Silver Line Phase 2 extension project consists of the design and construction of the six (6) new Metrorail stations, and the Railyard and Maintenance Facilities. WMATA requires delivery and installation of new shop storage racks to the facilities within the new Metrorail yard at the Dulles International Airport. The shop storage racking system represents the needs of each functional area of the facility in coordination with the WMATA stakeholders/users.

3. Locations

Project Acronym	Dulles Railyard and Maintenance Facilities	
	Facility Name	Building/Street Address
WHB	Warehouse (Bldg D)	23007 Dulles Yard Drive, Sterling, VA 20166
MWB	Maintenance of Way Building (Bldg E)	23030 Dulles Yard Drive, Sterling, VA 20166
SIB	Service & Inspection Building (Bldg F)	23099 Dulles Yard Drive, Sterling, VA 20166

4. Scope of Work

4.1 General

The Contractor shall provide the warehouse and rack shelving for each location/facility per requirements listed further in the Building Facility Furniture and Equipment Layout Plans and Schedule (Attachment A) of this SOW. The Contractor shall furnish all labor, supervision, materials, supplies, tools, equipment and expertise necessary to perform the installation of the rack shelving. The Contractor shall work in coordination with the Authority, as well other personnel of WMATA and other project team members, including meeting all requirements outlined in Attachment C regarding Safety, Security and Access to the site.

The services called for under this contract shall be performed in accordance with the terms, conditions and specifications stated herein until such time as said services are completed to the satisfaction of WMATA.

The Contractor shall comply with all applicable technical documents and equipment specifications defined in the Warehouse and Rack Shelving Requirements Manual (Attachment B). Images and renderings included in the specification sheets are provided for representational purposes of WMATA's requirements and design intent, and are not intended to restrict product selection to the any given manufacturer.

The delivery schedule will be contingent upon WMATA's acceptance of the completed space at the identified locations above. In the event that the delivery dates must be changed, due to construction or other causes, WMATA may modify the terms of this contract.

4.2 Summary of work to be performed

The Contractor shall supply and install the warehouse and rack shelving that meets the performance criteria and specifications shown in Attachment B. The scope of the services to be performed by the Contractor will include the following:

1. Supply and install storage rack shelving that either meets or exceeds the specifications as defined in Attachment B – Shop Storage Rack System Requirements Manual. WMATA and project team will approve rack shelving from the selected Contractor prior to delivery and installation.
2. Deliver, assemble and install the rack shelving at each location. Refer to the Warehouse and Rack Shelving Units Schedule in Attachment B for the quantity and locations, and in the drawings in Attachment A for specific location within each building.
3. Furnish all supplies, tools and equipment such as anchors, and lift equipment necessary to perform the assembly and installation of the rack shelving.
4. Unload shipments at rack shelving locations. Provide protection for installed finishes as indicated in Attachment B. The Contractor shall be solely responsible for damages occurring as a result of unloading and delivery of equipment.
5. Submit P.E. Engineering stamped drawings and engineering calculations.
6. Install labels with designated beam capacities.
7. Clear and dispose existing/original/excess/packing materials.

4.3 Submittals

Provide submittals listed below and as required in attachments to this scope of work. All submissions must be reviewed and approved by the WMATA Program Office and designated equipment end user representatives. The Contractor shall allow 21-days for WMATA review of all submittals.

1. Contract Deliverable Requirements List (CDRL)

1.1 Within 15 days of issuance of a Notice of Award, submit list of contract deliverable requirements with anticipated submission dates, coordinated with the performance schedule.

2. Performance Schedules

2.1 Bidders shall submit a Critical Path Method (CPM) style bar chart *with their Pre-Award Data* showing in days/ weeks of time of award, submittal review and approvals, material lead time, shipping & delivery time, installation time and punch list time.

2.2 Within 5 days of issuance of Notice to Proceed, the Contractor shall submit an updated CPM schedule for approval by WMATA, which includes, at a minimum, the following activities:

- 2.2.1 Submittals (as individual activities)
- 2.2.2 Equipment lead times (or availability)/delivery
- 2.2.3 Installation
- 2.2.4 Timelines for tasks
- 2.2.5 Milestone plans
- 2.2.6 Resource constraints

2.3 The Contractor shall provide regular updates to the schedule, if required or otherwise requested by the COTR.

3. Proposed Equipment and Material Submittals

3.1 Unless otherwise noted below, the Contractor shall submit all required submittals no later than 15 days after NTP and prior to placement of the final order.

3.2 Submit all material or products for final approval.

3.2.1 Buy America Act Certification for all Products

3.2.2 Product data sheets indicating compliance with the performance criteria and standards included in Attachment B, including composition, finish, durability, structural adequacy, warranty, availability of replacement /additional parts, probable life of product, test results, and any ANSI/BIFMA ratings.

3.2.3 Provide test records indicating compliance with the appropriate industry standard for the product for all submitted products.

Within 3.3 21-days of issuance of Notice to Proceed, submit structural shop drawings and engineering calculations for review and approval.

4. Safety Submittals

4.1 Submit for approval any required documents as outlined in Attachment C - Safety Security and Access Requirements.

5. Punchlist

5.1 Notify WMATA COTR, or designated representative, of readiness to perform final punchlist inspection.

5.2 Submit final punchlist and schedule for completion for review and concurrence by WMATA's COTR, or designated representative.

6. Closeout Deliverables.

6.1 After initial approvals and installation, the Contractor shall submit for approval all items listed under deliverables below.

5. Deliverables

In addition to the submittals noted above, and delivery and installation of the specified product, the Contractor shall provide the following Closeout deliverables prior to final acceptance.

1. Product Data & Owner's Manual Binder

1.1 Provide organized binder of all products provided

1.2 Binder Organization

a. Title page

b. Table of Contents

c. Shop Furniture Index

d. Manual contents

1.3 Title Page

a. Include Project Name, Contractor Name

1.4 Table of Contents

a. List each section of the binder, with page number references

1.5 Record Index of Equipment

a. Provide list of all equipment

b. Provide the following information for each item provided:

- 1. Descriptive name
- 2. Manufacture
- 3. Manufacturer's Product name
- 4. Manufacturer's Model number
- 5. Installation location, including building and room number
- 6. Replacement cost for each item
- 7. Warranty Info

1.6 Final record submittal documents for each product. For assembled equipment elements, include installation drawings and/or assembly instructions, spare parts listing and procurement sourcing information.

1.7 Include Product Warranties

2. Final completed punchlist record with signatures indicating acceptance by WMATA's designated field representative.

6. Performance and Acceptance Criteria

6.1 Performance Criteria

- See Attachment B for performance criteria and warehouse and rack shelving schedule.
- All furnished rack shelving shall be fully functional and structurally designed upon delivery/installation.
- Upon notification of by the Contractor, WMATA will perform an operational inspection to determine that all rack shelving are installed properly and free from manufacturing and material defects and are suitable for use.
- Warehouse and rack shelving must either meet or exceed predefined specifications.

6.2 Performance Schedules

The Contractor shall complete all the Work described in this Scope of Work within a period of 95 days after the Notice to Proceed.

Action	Dates
Deliver/Install Warehouse Racks	Mon 12/31/18 to Fri 1/11/19
Deliver/Install SIB Racks	Mon 1/14/19 to Fri 1/18/19
Deliver/Install MWB Racks	Mon 1/21/19

6.3 Acceptance Criteria

- 1. Submittals will be reviewed for compliance with performance criteria.
- 2. All changes to equipment locations or products shall be subject to approval by WMATA Program Office.
- 3. After completion of each installation, the Contractor shall provide notice of completion and request for punchlist inspection. WMATA's COTR or his appointees will perform a final punchlist inspection.

7. Location of Work and any Constraints

- Vendor shall deliver the equipment (FOB destination) to locations listed above.
- Contractor's personnel shall be fully OSHA trained on all ground equipment being used for the installation. Delivery vendor and subcontracted installer(s) shall meet all WMATA requirements for permissions to access the WMATA Dulles Rail Yard property. The Dulles Railyard is a secured facility. Employees working in WMATA facilities will need IDs and clearance to work. See Safety, Security and Access (Attachment C) for additional details.
- The Contractor and any of his Subcontractors installers are advised that participation in the Owner Controlled Insurance Program and observance of all site required safety rules (including personal protective equipment) is a requirement of this scope.
- The warehouse and rack shelving units shall be delivered and unloaded to the designated facility, and be placed at or as close as possible to the installation area as reflected in the furniture and equipment layout plans (Attachment A).
- There are sufficient parking spaces within the Railyard for the contractor's employees use during the projected installation period.
- Work hours are between 7:00 am and 3:30 pm. The Contractor shall contact COTR two (2) calendar days prior to the delivery date. Any damage(s) incurred in shipping the equipment is the sole responsibility of the Contractor.

APPENDIX B

**NOTICE OF REQUIREMENTS
FOR
DISADVANTAGED BUSINESS ENTERPRISE (DBE)**

May 2015

~Applies only if proposal price is \$500,000 or more for a construction contract or \$150,000 or more for a supply and service contract.

~APPENDIX B~

DISADVANTAGED BUSINESS ENTERPRISE (DBE)

1. DISADVANTAGED BUSINESS ENTERPRISE (DBE) REQUIREMENT:

- A. The DBE requirements of the Authority's DBE Program Plan apply to this contract. Accordingly, the Contractor shall carry out the requirements of the Authority's DBE Program Plan and this Appendix in the award and administration of this U.S. Department of Transportation (US DOT) assisted contract.

2. POLICY:

- A. It is the policy of the Authority (WMATA), the Federal Transit Administration (FTA) and the US DOT that Disadvantaged Business Enterprises (DBEs) shall compete fairly to receive and participate in performing federally assisted contracts, including contracts and subcontracts at any tier. It is further the policy of the Authority, the FTA and the US DOT that its prime contractors establish procedures to ensure the timely payment of amounts due pursuant to the terms of their subcontracts. The Contractor hereby agrees to carry out this policy in the award and administration of subcontracts to the fullest extent possible consistent with efficient Contract performance.

3. CONTRACT GOAL:

- A. If the bidder is not a DBE, the bidder agrees that the DBE goal for this Contract shall be met by subcontractors or by joint ventures with DBEs. The goal set forth for this Contract is ___% of the final Contract price, including amendment and modification. The amount of DBE participation will be determined by the dollar value of the work performed and/or supplies furnished by DBE firms as compared to the total value of all work performed and/or supplies furnished under this Contract. The Contractor shall have met this goal if the Contractor's DBE participation meets or exceeds this goal.
- B. In cases where work is added to the Contract by modification such that additional DBE participation is necessary to meet this goal, the Contractor shall increase the participation of one or more firms listed on the "Schedule of DBE Participation" or submit additional DBE certified firms to meet the goal. In cases where work is deleted from the Contract, the goal shall be applicable to the new Contract amount. The Contractor shall be permitted to meet the goal by revising its DBE participation, provided, however, that the revision shall not result in DBE participation that is less than the original goal.

4. DEFINITIONS:

- A. **Appendix B.** The Notice of Requirements for Disadvantaged Business Enterprise, which when attached to a solicitation, implements the DBE requirements of the Authority's DBE Program Plan in the award and administration of federally funded Authority contracts.
- B. **Certified DBE.** means a for-profit small business concern (a) that is at least fifty one percent (51%) owned by one or more individuals who are both socially and

economically disadvantaged or, in the case of a corporation, in which fifty one percent (51%) of the stock is owned by one or more such individuals; (b) whose management and daily business operations are controlled by one or more of the socially and economically disadvantaged individuals who own it; and (c) whose eligibility is evidenced by a current WMATA Certification letter, a D.C. Department of Transportation Certification letter, or a certification letter issued by the Metropolitan Washington Unified Certification Program (MWUCP).

- C. **Contractor.** One who participates, through a contract or subcontract (at any tier), in a US DOT assisted highway, transit or airport program.
- D. **DC DOT.** The District of Columbia Department of Transportation.
- F. **Good Faith Efforts.** Efforts to achieve a DBE goal or other requirements of the Authority's DBE Program Plan which by their scope, intensity, and appropriateness to the objective, can reasonably be expected to fulfill the goal program requirement.
- G. **Joint Venture.** An association of a DBE firm and one (1) or more other firms to carry out a single, for-profit business enterprise, for which the parties combine their property, capital, efforts, skills and knowledge, and in which the DBE is responsible for a distinct, clearly defined portion of the work of the contract and shares in the capital contribution, control, management, risks, and profits of the joint venture commensurate with its ownership interest.
- H. **Metropolitan Washington Unified Certification Program (MWUCP).** A unified certification program mandated by 49 C.F.R. §26.81 between two Federal transit recipients (WMATA and the D.C. Department of Transportation). The agreement became effective January 2005.
- I. **Pre-certification.** A requirement under 49 C.F.R. §26.81(c) that all certifications by the MWUCP be made final before the due date for bids or offers on a contract on which a firm seeks to participate as a DBE.
- J. **Race-conscious.** A measure or program that is focused specifically on assisting only DBEs, including women-owned DBEs.
- K. **Race-neutral.** A measure or program that is, or can be, used to assist all small businesses. For the purposes of the DBE program, race-neutral includes gender-neutrality.
- L. **Small Business Concern.** With respect to firms seeking to participate as DBEs in US DOT assisted contracts, a small business concern as defined pursuant to Section 3 of the Small Business Act and Small Business Administration implementing regulations (13 C.F.R. Part 121) that also does not exceed the cap on average annual gross receipts specified in 49 CFR § 26.65(b).
- M. **Socially and Economically Disadvantaged Individual.** Any individual who is a citizen (or other lawfully admitted permanent resident) of the United States and who the Authority finds to be a socially and economically disadvantaged individual on a case-by-case basis, and any individual in the following groups, members of which are rebuttably presumed to be socially and economically disadvantaged.

- (1) Black Americans, which includes persons having origins in any of the Black racial groups of Africa;
 - (2) Hispanic Americans, which includes persons of Mexican, Puerto Rican, Cuban, Dominican, Central or South American, or other Spanish or Portuguese culture or origin, regardless of race;
 - (3) Native Americans, which includes persons who are American Indians, Eskimos, Aleuts, or Native Hawaiians;
 - (4) Asian-Pacific Americans, which includes persons whose origins are from Japan, China, Taiwan, Korea, Burma (Myanmar), Vietnam, Laos, Cambodia (Kampuchea), Thailand, Malaysia, Indonesia, the Philippines, Brunei, Samoa, Guam, the U.S. Trust Territories of the Pacific Islands (Republic of Palau), the Commonwealth of the North Marianas Islands, Macao, Fiji, Tonga, Kiribati, Juvalu, Nauru, Federated States of Micronesia, or Hong Kong;
 - (5) Subcontinent Asian Americans, which includes persons whose origins are from India, Pakistan, Bangladesh, Bhutan, the Maldives Islands, Nepal or Sri Lanka;
 - (6) Women; and
 - (7) Any additional groups whose members are designated as socially and economically disadvantaged by the SBA, at such time as the SBA designation becomes effective.
- N. US DOT Assisted Contract. Any contract between the Authority and a contractor (at any tier) funded in whole or in part with US DOT financial assistance, including letters of credit or loan guarantees.
- O. Unified Certification Program (UCP). The program mandated by 49 C.F.R. § 26.81(a), which requires all U. S. DOT recipients of Federal financial assistance to participate in a statewide certification program by March 2002.
- P. WMATA. Washington Metropolitan Area Transit Authority, the transit system (rail and bus) serving the metropolitan Washington area, including parts of Virginia and Maryland.

5. HOW DBE PARTICIPATION IS COUNTED TOWARDS THE CONTRACT GOAL:

DBE participation shall be counted towards meeting the DBE goal in accordance with the following:

- A. When a DBE participates in a contract, only the value of the work actually performed by the DBE is counted towards the DBE goal.
 - (1) This amount includes the entire amount of that portion of a construction contract that is performed by the DBE's own forces. This amount includes the cost of supplies and materials obtained by the DBE for the work of the contract, including supplies purchased or equipment leased by the DBE

(except supplies and equipment the DBE subcontractor purchases or leases from the prime contractor or its affiliate).

- (2) This amount includes the entire amount of fees or commissions charged by a DBE firm for providing a bona fide service, such as professional, technical, consultant, or managerial services, or for providing bonds or insurance specifically required for the performance of the contract, towards the DBE goal, provided the fee is reasonable and not excessive as compared with fees customarily allowed for similar services.
 - (3) When a DBE subcontracts part of its work under the contract to another firm, the value of the subcontract work may be counted towards the DBE goal only if the DBE's subcontractor is itself a DBE. Work that a DBE subcontracts to a non-DBE firm does not count towards the DBE goal.
- B. When a DBE performs as a participant in a joint venture, the portion of the total dollar value of the contract equal to the distinct, clearly defined portion of the work of the contract that a DBE performs with its own forces towards the DBE goal may be counted.
- C. Expenditures to a DBE contractor towards the DBE goal may be counted only if the DBE is performing a commercially useful function on that contract.
- (1) A DBE performs a commercially useful function when it is responsible for execution of the work of the contract and is carrying out its responsibilities by actually performing, managing, and supervising the work involved. To perform a commercially useful function, the DBE must also be responsible, with respect to materials and supplies used on the contract, for negotiating price, determining quality and quantity, ordering the material, and installing (where applicable) and paying for the material itself. To determine whether a DBE is performing a commercially useful function, the Authority will consider the amount of work subcontracted, industry practices, whether the amount the firm is to be paid under the contract is commensurate with the work it is actually performing and the DBE credit claimed for its performance of the work, and other relevant factors.
 - (2) A DBE does not perform a commercially useful function if its role is limited to that of an extra participant in a transaction, contract, or project through which funds are passed in order to obtain the appearance of DBE participation.
 - (3) If a DBE does not perform or exercise responsibility for at least 30 percent of the total cost of its contract with its own work force, or if the DBE subcontracts a greater portion of the work of a contract than would be expected on the basis of normal industry practice for the type of work, the Authority will presume that the DBE is not performing a commercially useful function.
- D. The following factors will be used by the Authority in determining whether a DBE trucking company is performing a commercial useful function:
- (1) The DBE must be responsible for the management and supervision of the entire trucking operation for which it is responsible for on a particular

contract, and there cannot be a contrived arrangement for the purpose of meeting the DBE goal.

- (2) The DBE must itself own and operate at least one fully licensed, insured and operational truck used on the contract.
- (3) The DBE receives credit for the total value of the transportation services it provides on the contract using trucks it owns, insures, and operates using drivers, it employs.
- (4) The DBE may lease trucks from another DBE firm, including an owner-operator who is certified as a DBE. The DBE who leases trucks from another DBE receives credit for the total value of the transportation services the lessee DBE provides on the contract.
- (5) The DBE may also lease trucks from a non-DBE firm, including an owner-operator. The DBE who leases trucks from a non-DBE is entitled to credit only for the fee or commission it receives as a result of the lease arrangement. The DBE does not receive credit for the total value of the transportation services provided by the lessee, since these services are not provided by a DBE.
- (6) The lease must indicate that the DBE has exclusive use of and control over the truck. This does not preclude the leased truck from working for others during the terms of the lease with the consent of the DBE, so long as the lease gives the DBE absolute priority for use of the leased truck. Leased trucks must display the name and identification number of the DBE.

E. The following factors will be used to count expenditures with DBEs for materials or supplies towards the DBE goal:

- (1) If the materials or supplies are obtained from a DBE manufacturer, one hundred percent (100%) of the cost of the materials or supplies will be counted towards the DBE goal. A manufacturer is a firm that operates or maintains a factory or establishment that produces, on the premises, the materials, supplies, articles, or equipment required under the contract and of the general character described by the contract.
- (2) If the materials or supplies are purchased from a DBE regular dealer, sixty percent (60%) of the cost of the materials or supplies will be counted towards the DBE goal. A regular dealer is a firm that owns, operates or maintains a store, warehouse, or other establishment in which the materials, supplies, articles or equipment of the general character described and required under the contract are bought, kept in stock, and regularly sold or leased to the public in the usual course of business. To be a regular dealer, the firm must be an established, regular business that engages, as its principal business and under its own name, in the purchase and sale or lease of the products in question. A person may be a regular dealer in such bulk items as petroleum products, steel, cement, gravel, stone or asphalt without owning, operating, or maintaining a place of business as provided in this paragraph if this person both owns and operates distribution equipment for the products. Any supplementing of regular dealers' own distribution equipment shall be by long-term lease agreement and not on an ad hoc or contract-by-contract

basis. Packagers, brokers, manufacturers' representatives, or other persons who arrange or expedite transactions are not regular dealers within the meaning of this paragraph.

- (3) With respect to materials or supplies purchased from a DBE which is neither a manufacturer nor a regular dealer, the entire amount of fees or commissions charged for assistance in the procurement of the materials and supplies, or fees or transportation charges for the delivery of materials and supplies required on a job site, may be counted towards the DBE goal, provided the fees are reasonable and are not excessive as compared to fees customarily allowed for similar services. The cost of the materials and supplies themselves may not be counted towards the DBE goal.
- F. All DBE firms must be pre-certified. Participation by a firm that is not currently Authority certified as a DBE at the time of bid opening, does not count towards the DBE goal. All DBE firms must be in compliance with 49 CFR, Part 26.
- G. The dollar value of work performed under this Contract by a firm that MWUCP decertifies as a DBE does not count towards the DBE goal.
- H. The participation of a DBE subcontractor does not count towards the Contractor's DBE goal, until the amount being counted towards the goal has been paid to the DBE.

6. BIDS AND REQUIREMENTS (WITH THE BID):

The bidder shall submit the following with its bid. Any bidder who fails to complete and return this information with its bid shall be deemed to be not responsive and may be ineligible for Contract award. Bidders that fail to meet the DBE goal above and fail to demonstrate "good faith efforts" to justify waiver of the DBE goal (See paragraph 6.C. below) shall be deemed to be not responsible and will be ineligible for Contract award.

- A. Completed "Schedule of DBE Participation" (Attachment B-1) sufficient to meet the above goal. If the bidder is a DBE firm and intends to satisfy the appropriate DBE requirement with its own firm, it must indicate in the Schedule the area of work and percentage it will perform to satisfy the goal. All offerors must attach current WMATA, DC DOT or MWUCP certification letters for each DBE listed on the Schedule.
- B. Executed "Letters of Intent to Perform as a Subcontractor/Joint Venture" (Attachment B-2). If the bidder is not a DBE or intends to satisfy the requirements through other DBE firms, then it must attach these letters from each certified DBE listed on the Schedule.
- C. Justification for grant of relief (Appendix B waiver of DBE goal). If in the submittal of its bid, the bidder fails to meet the DBE goal above, the bidder has the burden of furnishing sufficient documentation with its bid of its "good faith efforts" to justify a grant of relief (waiver) from the goal or portion of the goal. Such justification shall be in the form of a detailed report. The following is a list of actions that shall be considered as part of the bidder's good faith efforts to obtain DBE participation. This list is neither a mandatory checklist nor is it intended to be exclusive or exhaustive. Other factors or types of efforts may be relevant in appropriate cases:

- (1) Soliciting through all reasonable and available means (e.g. attendance at pre-bid meetings, advertising and/or written notices) the interest of all certified DBEs who have the capability to perform the Contract. The bidder must solicit this interest within sufficient time to allow the DBEs to respond to the solicitation. The offeror must determine with certainty if the DBEs are interested by taking appropriate steps to follow up initial solicitations.
- (2) Selecting portions of the work to be performed by DBEs in order to increase the likelihood that the DBE goal will be achieved. This includes, where appropriate, breaking out Contract work items into economically feasible units to facilitate DBE participation, even when the prime contractor might otherwise prefer to perform these work items with its own forces.
- (3) Providing interested DBEs with adequate information about the plans, specifications, and requirements of the contract in a timely manner to assist them in responding to a solicitation.
- (4) Negotiating in good faith with interested DBEs. It is the offeror's responsibility to make a portion of the work available to DBE subcontractors and suppliers and to select those portions of the work or material needs consistent with the available DBE subcontractors and suppliers, so as to facilitate DBE participation. Evidence of such negotiation includes the names, addresses, and telephone numbers of DBEs that were considered; a description of the information provided regarding the plans and specifications for the work selected for subcontracting; and evidence as to why additional agreements could not be reached for DBEs to perform the work. "DBE Unavailability Certifications" (Attachment B-3) shall be completed as appropriate.
- (5) An offeror using good business judgment would consider a number of factors in negotiating with subcontractors, including DBE subcontractors, and would take a firm's price and capabilities as well as the Contract goal into consideration. However, the fact that there may be some additional costs involved in finding and using DBEs is not in itself sufficient reason for a bidder's failure to meet the contract DBE goal, as long as such costs are reasonable. Also, the ability or desire of a prime contractor to perform the Contract with its own organization does not relieve the offeror of the responsibility to make good faith efforts. Prime contractors are not, however, required to accept higher quotes from DBEs, if the price difference is excessive or unreasonable.
- (6) Not rejecting DBEs as being unqualified without sound reasons based on a thorough investigation of their capabilities. The contractor's standing within its industry, membership in specific groups, organizations, or associations and political or social affiliations (for example union vs. non-union employee status) are not legitimate causes for the rejection or non-solicitation of bids in the Contractor's efforts to meet the project goal.
- (7) Making efforts to assist interested DBEs in obtaining bonding, lines of credit, or insurance as required by the recipient or contractor.
- (8) Making efforts to assist interested DBEs in obtaining necessary equipment, supplies, materials, or related assistance or services.

- (9) Effectively using the services of available minority/women community organizations; minority/women contractors' groups; local, state, and Federal minority/women business assistance offices; and other organizations as allowed on a case-by-case basis to provide assistance in the recruitment and placement of DBEs.

7. BID REQUIREMENTS (APPARENT LOW BIDDER):

The bidder shall submit the following items within ten (10) calendar days after notification that they are the apparent low bidder:

- A. A copy of a current WMATA, D.C. DOT or MWUCP certification letter(s) shall be attached to the DBE Schedule of Participation to evidence DBE pre-certification.
- B. DBE Manufacturer's Affidavit, if applicable, must be submitted in order to receive one hundred percent (100%) of the allowable credit for expenditures to DBE manufacturers/suppliers (Attachment B-4). By submission of this affidavit, the bidder certifies this it is satisfied that the manufacturer meets the requirements of 49 CFR Part 26.
- C. Schedule B Information for Determining Joint Venture Eligibility, if applicable (Attachment B-5, pgs. 1-4). Submittal shall be signed by all parties, dated and notarized.
- D. Copy of Joint Venture Agreement, if applicable. Submittal shall be signed by all parties, dated and notarized.
- E. Certification letter of the DBE regular dealer/supplier, if applicable. If the bidder wants to receive the maximum allowable credit for its expenditures for material(s) or supplies required under this Contract, from DBE regular dealers/suppliers, the DBE must submit a signed and notarized statement on their letterhead, stating that it is a regular dealer of the material(s) or supplies. By submission of this statement, the bidder certifies that it is satisfied that the subcontractor is a regular dealer/supplier that meets the requirements of 49 CFR Part 26.
- F. For design-build contracts, if a DBE goal is specified in the DBE GOAL/ REQUIREMENTS, the bidder shall submit, with its initial bid, a list of DBE-certified firms that it intends to enter into subcontract agreements with for this Contract. If no goal is specified in the solicitation and the bidder still intends to utilize DBEs in the performance of this Contract, the offeror shall submit with its initial bid a list of those DBE-certified firms. The documentation requirements of the solicitation shall be completed and submitted at the time of bid opening for any Contract in which a DBE goal is applicable or for any Contract in which there was no goal established, but the offeror identified DBE-certified firms that it intended to enter into subcontract agreements with in its initial bid. Any bidder who fails to complete and return the following information, if applicable, with its bid may be deemed to be not responsible and may be ineligible for Contract award. Offerors that fail to meet the DBE goal, if any, specified in the solicitation and fail to demonstrate a good faith effort and/or to justify waiver of the DBE goal, may be deemed to be not responsible and may be ineligible for contract award.

8. CONTRACT ADMINISTRATION REQUIREMENTS:

The following requirements apply after contract award:

- A. The Contractor shall include the following provision in each subcontract it awards in support of the DBE goal:
- “The contractor shall not discriminate on the basis of race, color, national origin or sex in the performance of this contract. The contractor shall carry out applicable requirements of 49 CFR Part 26 in the award and administration of US DOT assisted contracts. Failure by the contractor to carry out these requirements is a material breach of this contract, which may result in termination of this contract or such other remedy as the Buyer deems appropriate.”
- B. (1) The Contractor shall monitor the performance of, collect and report data on DBE participation to WMATA’s Small Business Programs Office on the WMATA website at www.wmata.com under Doing Business with WMATA and on the attached “Prompt Payment Report-Prime Contractor’s Report” (Attachment B-6) which shall be submitted monthly with each payment request. Failure to submit these reports may result in suspension of contract payments. The Contractor shall certify with each payment request that payment has been or will be made to all subcontractors due payment, within ten (10) days after receipt of payment from the Authority for work by that subcontractor. The Contractor shall inform the COR or COTR, with their payment request, of any situation in which scheduled subcontractor payments have not been made and the reason therefore.
- (2) The Contractor shall require each subcontractor to report Prompt Payment data to WMATA’s Small Business Programs Office online at www.wmata.com under Doing Business with WMATA and on a monthly basis using the attached “Prompt Payment Report-Subcontractor’s Report” (Attachment B-7). The subcontractor shall certify that payment has been received.
- (3) The Contractor and the subcontractor are required to have Prompt Payment reporting training for each WMATA contract which has been awarded to them. Failure to complete this training may result in suspension of contract payments.
- C. The Contractor shall have a continuing obligation to maintain a schedule for participation by DBE contractor(s) to meet its goal set forth above in this Appendix. The Contractor shall not have work performed nor the materials or supplies furnished by any individual or firm other than those named in the “Schedule of DBE Participation.” If at any time, the Contractor believes or has reason to believe that it needs to obtain a substitute for a DBE contractor named in the “Schedule of DBE Participation”, the Contractor shall, within ten (10) days, notify the Contracting Officer and the Small Business Programs Office of that fact in writing on (Attachment B-8). A copy of this written request will be forwarded to the DBE vendor. The vendor shall have ten (10) days to respond in writing to the Contracting Officer. The Contracting Officer shall meet with the DBE Liaison Officer to review the documentation submitted. A written determination will be made within ten (10) days on whether to approve or deny the request. There is no appeal to this decision. A copy of this

decision shall be maintained in the contract file. Situations which may warrant substitution for a DBE firm include, but are not limited to the following:

- (1) Evidence of change in ownership or circumstances regarding the firm's status as a DBE.
- (2) Death or physical disability, if the named subcontractor or DBE partner of the joint venture is an individual.
- (3) Dissolution, if a corporation or partnership.
- (4) Bankruptcy of the subcontractor, subject to applicable bankruptcy law, and only instances where the bankruptcy affects the Contractor's ability to perform.
- (5) Inability to furnish a reasonable performance or payment bond, if required.
- (6) Inability to obtain, or loss of, a license necessary for the performance of the particular category of work.
- (7) Failure or inability to comply with a requirement of law applicable to contractors and subcontractors on a construction, alteration or repair project.
- (8) Failure or refusal to execute the subcontract in accordance with the terms of an offer submitted to the Contractor prior to the Contractor's submission of its offer, but only where the Contracting Officer or other delegated Authority representative can ascertain with reasonable certainty the terms of such offer. In the absence of any other factors, such a failure or refusal will be considered an unusual situation only if the offeror obtained, prior to bidding/proposing, an enforcement commitment from the subcontractor involved.
- (9) Failure to comply with the terms and conditions of this Contract or those of its subcontract or joint venture agreement.

The Contractor must have the prior, written approval of the Contracting Officer and the DBE Liaison before substitution of a DBE subcontractor, regardless of the reason for substitution. Failure to obtain the Authority's approval could result in the Contractor's suspension or debarment.

If the request for substitution is approved, within thirty (30) days thereafter, the Contractor shall, if necessary to achieve the Appendix B goal, make every reasonable effort to subcontract the same or other work equivalent in value to other certified DBE firms. These efforts must be submitted in writing to the Contracting Officer and the DBE Liaison Officer. Examples of reasonable efforts include, but are not limited to the following:

1. documentation of efforts made to assist the DBEs contacted that needed assistance in obtaining bonding or insurance required by the bidder or the Authority;

2. documentation of efforts to utilize the services of small business organizations, community and contractor groups to locate qualified DBEs;
 3. documentation that the bidder has broken out contract work items into economically feasible units in fields where there are available DBE firms to perform the work; and
 4. evidence that adequate information was provided to interested DBEs about the plans, specifications and requirements of the contract, and that such information was communicated in a timely manner.
- D. The Contractor shall forward copies of all subcontracts to the DBE Office at the time of their execution.
- E. If the Contracting Officer or other delegated Authority representative determines that the Contractor has failed to comply with this Appendix B, he/she will notify the Contractor of such noncompliance and the action to be taken. The Contractor shall, after receipt of such notice, take corrective action. If the Contractor fails or refuses to comply promptly, the Contracting Officer or other delegated Authority representative may issue a "stop work order" stopping all or part of the work until satisfactory corrective action has been taken. No part of the time lost due to any such stop work order shall be made the subject of claim for extension of time or for excess costs or damages by the Contractor. When the Authority proceeds with such formal actions, it has the burden of proving that the Contractor has not met the requirements of this Appendix. The Contractor's failure to meet its Appendix B goal shall shift the burden to it to show that it has met the good faith requirements of this Appendix. After exhausting all of its administrative and legal remedies, if the Contractor is found to have failed to exert a "good faith effort" to involve DBEs in the work, the Authority may suspend or debar the Contractor.
- F. The Contractor agrees to cooperate in any studies or surveys as may be conducted by the Authority which are necessary to determine the extent of the Contractor's compliance with this Appendix.
- G. The Contractor shall keep records and documents for two (2) years following performance of this Contract to indicate compliance with this Appendix. These records and documents, or copies thereof, shall be made available at reasonable times and places for inspection by any authorized representative of the Authority and will be submitted upon request, together with any other compliance information that such representative may require.
- H. If the Authority, FTA or the US DOT has reason to believe that any person or firm has willfully and knowingly provided incorrect information or made false statements regarding the DBE Program, the matter shall be referred to WMATA's DBE office, and WMATA's Office of Inspector General (OIG).
- I. Failure by the Contractor to carry out the requirements of this Appendix is a material breach of this Contract, that may result in the termination of this Contract or such other remedy as the Authority deems appropriate.

SUMMARY OF SUBMITTALS

With the Bid:

1. Completed "Schedule of DBE Participation" (Attachment B-1) with current certification letters attached for each listed DBE.
2. Executed "Letters of Intent to Perform as a Subcontractor/Joint Venture" (Attachment B-2).
3. Justification for grant of relief (waiver of DBE goal), if applicable. Include completed "DBE Unavailability Certifications" (Attachment B-3) as appropriate.

Bid Requirements (Apparent Low Bidder)

1. All DBEs must submit copies of their current WMATA or D.C. DOT certification letters or a certification letter issued by the MWUCP.
2. A DBE Manufacturer's Affidavit, if applicable, must be submitted in order to receive one hundred percent (100%) of the allowable credit for expenditures to DBE manufacturers/suppliers (Attachment B-4).
3. Schedule B Information for Determining Joint Venture Eligibility, if applicable (Attachment B-5, pgs. 1, 2, 3, 4).
4. Copy of Joint Venture Agreement, if applicable.
5. Certification letter of the DBE regular dealer/supplier, if applicable.

After Contract Award

1. "Prompt Payment Report-Prime Contractor's Report" Attachment B-6) – submitted monthly.
2. "Prompt Payment Report-Subcontractor's Report" (Attachment B-7) - submitted monthly.
3. Request to substitute DBE contractor (see paragraph 8.C.) – submitted as required.
4. Copies of subcontracts-submitted at the time of their execution.

**SUBMIT WITH BID
SCHEDULE OF DBE PARTICIPATION**

Contract No. _____

Project Name _____

Name of Bidder

The bidder shall complete this Schedule by identifying only those DBE firms, (with scope of work and price) who have agreed to perform work on this Contract. The prices shall be at an amount that is at least the DBE percentage goal for the total Contract. The offeror agrees to enter into a formal agreement with the DBE firm(s) listed for the work, at an amount equal to, or greater than, the prices listed in this Schedule, subject to award of a Contract with the Authority. If the total amount is less than the DBE percentage goal, a justification for waiver of DBE goal shall be attached to this Schedule.

Name of DBE Subcontractor	Address	Type of Work (Electrical, Paving, Etc.) and Contract Items or Parts Thereof to be Performed and Work Hours Involved	Agreed Price
Subtotal \$ DBE Subcontractors			
Name of DBE Prime Contractor	Address	Type of Work (Electrical, Paving, Etc.) and Contract Items or Parts Thereof to be Performed and Work Hours Involved	Agreed Price
Subtotal \$ DBE Prime Contractor			
TOTAL \$ ALL DBE CONTRACTORS		TOTAL	

_____ Signature of Contractor' Representative

_____ Title

_____ Date

M 23.26a (Rev 02/12)

Contract Number: _____

Project Name: _____

**LETTER OF INTENT TO PERFORM AS A SUBCONTRACTOR/JOINT VENTURE
(ALL ITEMS MUST BE COMPLETED)**

TO: _____
(Name of Offeror)

The undersigned intends to perform work in connection with the above projects as (check one):

_____ An individual _____ A corporation
_____ A partnership _____ A joint venture

Specify in detail particular work items or parts thereof to be performed:

at the following price: \$

Please indicate _____ % of the dollar value of the subcontract that will be awarded to non-DBE contractors, if applicable. The undersigned will enter into a formal agreement with you for the above work upon your execution of a contract with the Authority.

Name of DBE Subcontractor/Joint Venture

Phone Number

Address

WMATA Vendor ID #/DBE Cert. #

Signature & Title

Date

The following is to be completed by the Prime Contractor. A copy of this letter must be returned to the DBE subcontractor to indicate acceptance.

To: _____
(Name of DBE)

You have projected your interest and intent for such work, and the undersigned is projecting completion of such work as follows:

WORK ITEMS	PROJECTED DBE COMMENCEMENT DATE	PROJECTED DBE COMPLETION DATE
_____	_____	_____

(Date)

(Name of Prime Contractor &
Acceptance Signature)

SUBMIT WITH BID

DBE UNAVAILABILITY CERTIFICATION

I, _____, _____, of _____
(Name) (Title) (Bidder)

certify that on _____ I contacted the following DBE contractor(s) to obtain offer(s) for work
(Date)
items to be performed on Contract Number _____

DBE Contractor	Work Items Sought	Form of Bid Sought (i.e., Unit Price, Materials and Labor Only, Etc.)
_____	_____	_____

To the best of my knowledge and belief, said DBE contractors were unavailable (exclusive of unavailability due to lack of agreement on price) for work on this project, or unable to prepare a bid, for the following reason(s):

Signature: _____

Date: _____

_____ was offered an opportunity to submit a bid on the above
(Name of DBE Contractor)

identified work on _____ by _____
(Date) (Source)

The above statement is true and accurate account of why I did not submit an offer on this project.

(Signature of DBE Contractor)

(Title)

M 23.25 (Rev 10/99)

DBE Certification Instructions

Important Notice

If you do not have a current, official letter of certification from WMATA, D.C. DOT or MWUCP, you are not pre-certified and are therefore not eligible to participate as a Disadvantaged Business Enterprise on the bid.

For those who wish to access the MWUCP certification application, it may be found on the internet at the following address:

https://www.wmata.com/business/disadvantaged_business_enterprise. Go to “Procurement and Contracting”, click on “Disadvantaged Business Enterprise”, then click on “DBE Application for Certification”.

49 CFR Part 26 gives Metropolitan Washington Unified Certification Program (MWUCP) ninety (90) days in which to process a complete DBE application. In order to become certified and participate in the MWUCP, you must comply with the procedures that follow. Certification must be final before the due date for bids or offers on a contract on which a firm seeks to participate as a DBE.

Instructions

49 C.F.R. § 26.81(d) of the Certification Procedures requires a firm to be certified as a DBE in its “home state,” where its principal place of business is located, in order to become certified outside such “home state”. Therefore, you must attach to the MWUCP application, a copy of a valid DBE Certification letter from your home state’s Department of Transportation. In addition, submit the pertinent documents for your company listed below. The application should be completed in full and NOTARIZED.

General (All firms must submit these documents.)

- Current (unaudited) Financial Statements;
- Prior three (3) years Federal Tax Returns;
- Resume of Principal(s) and Key Personnel;
- Third Party Agreements, such as Rental and Management Agreements;
- Licenses to Do Business;
- Personal Net Worth (PNW) Statement;
- Statement of Disadvantage;
- No Change Affidavit or Notice of Change (where applicable).

Corporations

- Articles of Incorporation;
- By-Laws;
- Copies of any Stock Options;
- Copies of Stock Certifications of Each Holder;
- Copies of Stockholders’ Voting Rights;
- Record of First Organizational Meeting.

Partnerships

- Partnership Agreement

Proprietorships

IRS Employer ID Number
WMATA Vendor ID#

Limited Liability Companies

Operating Agreement with any amendments;
Certificate of Formation, U.S. Income Tax Returns.

Change of Status Review

On or before each certification anniversary date, you must submit a No Change Statement attesting that there have been no changes in the firm's circumstances affecting its ability to meet the eligibility requirements of 49 CFR Part 26 or WMATA's DBE Program Plan. Firms with changed circumstances must submit a Notice Regarding Change for review by the DBE Office. A review of these changes shall be made to determine if the firm is in compliance with the 49 CFR Part 26.

Affidavit Enclosure

NOTE: When completing MWUCP Application, complete all information blocks. Type "N/A" if item does not apply to you or your firm.

DBE MANUFACTURER'S AFFIDAVIT

I hereby declare and affirm that I am _____ (Title)
and duly authorized representative of _____ (Name of Company),
a _____ owned and controlled enterprise
whose address is _____

I further declare and affirm that company employees (persons not on the payroll of and/or performing the same tasks for disadvantaged owned business having any interest in the affiant's business) operate the following company equipment relative to the manufacturing process:

Equipment

Type	Function	Model	Age	Make
------	----------	-------	-----	------

Number of employees involved in the manufacturing process: _____

The undersigned swears that the foregoing statements are true and correct and fully understands that WMATA may rely on these statements in determining whether a WMATA prime contractor purchasing goods from the undersigned's manufacturing concern is entitled to a 100% credit of such purchases towards its DBE goal. The undersigned further understands that any material misrepresentation will be grounds for initiating action under Federal or state laws concerning false statements.

_____ Signature of Affiant	_____ Printed Name
-------------------------------	-----------------------

.....

Date: _____ State: _____ County: _____

On this _____ day of _____, 19_____

before me appeared _____
(Name)

to me personally known, who, being duly sworn, did execute the foregoing Affidavit, and did state that he or she was properly authorized by _____
(Name of Firm)

to execute the Affidavit and did so as his or her free act and deed.

(Seal) Sworn and subscribed before me _____
(Notary Public)

Commission Expires: _____

23.29 (10/99)

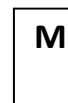

Information for Determining Joint Venture Eligibility

Page 1

.....
Name and address of Joint Venture:

Contact Person: _____ Telephone: _____

Have you attached a copy of the Joint Venture agreement? Yes No

NOTE: Affidavit will not be processed without a copy of the Joint Venture agreement.
.....

Name and address of Joint Venture partner: _____

Contact Person: _____ Telephone: _____

Status of firm: DBE. Non-Minority.

Does firm have current WMATA, D.C. DOT or MWUCP DBE certification? Yes No
.....

Name and address of Joint Venture partner: _____

Contact Person: _____ Telephone: _____

Status of firm: DBE. Non-Minority.

Does firm have current WMATA, D.C. DOT or MWUCP DBE certification? Yes No
.....

Describe the nature of the Joint Venture's business:

Describe the role in the Joint Venture of each partner listed above:

Describe the experience and business qualifications of each partner in the Joint Venture listed above:
.....

Information for Determining Joint Venture Eligibility

.....
Indicate the percentage of ownership in the Joint Venture for each Joint Venture partner, indicating dollar amounts wherever applicable.

Name of Partner	Percentage of Ownership	Profit and Loss Sharing	Capital Contributions including Equipment	Other Agreements
_____	_____	_____	_____	_____
_____	_____	_____	_____	_____
_____	_____	_____	_____	_____

TOTALS:

.....
Identify by name, title, race, sex and company affiliation those individuals responsible for the management control of and participation in this contract:

1. Financial decisions, such as payroll, insurance, surety and/or bonding requirements:

Name: _____ Race: _____

Title: _____ Sex: Male Female

Company affiliation: _____

2. Management decisions, such as estimating, marketing and sales, hiring and firing, purchasing supplies:

Name: _____ Race: _____

Title: _____ Sex: Male Female

Company affiliation: _____

3. Supervision of field operations:

Name: _____ Race: _____

Title: _____ Sex: Male Female

Company affiliation: _____

.....

M

 23.06c (Rev 10/99)

Information for Determining Joint Venture Eligibility

Page 3

.....
The undersigned swear that the foregoing statements are correct and include all material information necessary to identify and explain the terms and operations of our following named Joint Venture:

.....
and the intended participation by each Joint Venturer in the undertaking. Further, the undersigned covenant and agree to provide the Authority current, complete and accurate information regarding actual Joint Venture work and the payment thereof and any proposed changes in any of the Joint Venture arrangements and to permit the audit and examination of the books, records and files of the Joint Venture, or those of each Joint Venturer relevant to the Joint Venture, by authorized representatives of the Authority or the Federal funding agency. Any material misrepresentation will be grounds for terminating any contract which may be awarded and for initiating action under Federal and State laws concerning false statements.

It is recognized and acknowledged that the Authority's DBE Program shall have access to the information provided herein above for the purpose of establishing eligibility and authenticity of the minority/woman-owned status of the Joint Venture.

It is understood that trade secrets and information privileged by law, as well as commercial, financial, geological and geophysical data furnished will be protected.

_____ (NAME OF FIRM)	_____ (NAME OF SECOND FIRM)
_____ (SIGNATURE OF AFFIANT)	_____ (SIGNATURE OF AFFIANT)
_____ (PRINT NAME)	_____ (PRINT NAME)
_____ (TITLE)	_____ (TITLE)
_____ (DATE)	_____ (DATE)

.....
23.29 (10/99)

M

Information for Determining Joint Venture Eligibility

Page 4

.....
Date: _____ State: _____ County: _____

On this _____ day of _____, 19_____,
before me appeared _____

(Name)

to me personally known, who, being duly sworn, did execute the foregoing Affidavit, and did state that he or she was properly authorized by _____

(Name of Firm)

to execute the Affidavit and did so as his or her free act and deed.

(Seal) Sworn and subscribed before me _____
(Notary Public)

Commission Expires: _____

.....
Date: _____ State: _____ County: _____

On this _____ day of _____, 19_____,
before me appeared _____

(Name)

to me personally known, who, being duly sworn, did execute the foregoing Affidavit, and did state that he or she was properly authorized by _____

(Name of Firm)

to execute the Affidavit and did so as his or her free act and deed.

(Seal) Sworn and subscribed before me _____
(Notary Public)

Commission Expires: _____

.....

M

 23.06c (Rev 10/99)

Washington Metropolitan Area Transit Authority

DISADVANTAGED BUSINESS ENTERPRISE (DBE)
 MONTHLY PROMPT PAYMENT REPORT

PRIME – CONTRACTOR’S REPORT

This report is required to be submitted to the Office of Procurement, DBE Branch 600 5th Street, NW, Suite 3C, Washington, DC 20001, pursuant to the requirements of WMATA’s DBE Program Plan and §26.29 of 49 CFR Part 26.

Contract No.: _____ Reporting Period: _____

Name of Prime Contractor: _____ DBE – Yes or No

Prime Contract Amount: _____ Total Received this Reporting Period: _____ Total Received to Date: _____
 DBE Goal _____

Name of Sub-Contractor	DBE (Y/N)	Description of Work	Date of Contract Awarded	Amount of Sub-Contractor Award	Amount Paid This Reporting Period	Cumulative Paid To Sub-Contractor	% of Physical Work Complete
TOTAL							

I certify the information furnished with respect to DBE subcontractor performance correct to the best of my knowledge and represents a current status of the prime contractor with the DBE subcontractors for the designated period covered by this report. Further, those subcontractors, due payment pursuant to the terms of their subcontracts will be paid within ten days after receipt of payment from WMATA.

By: _____ Title: _____ Date: _____

Washington Metropolitan Area Transit Authority

DISADVANTAGED BUSINESS ENTERPRISE (DBE)
 MONTHLY PROMPT PAYMENT REPORT

SUBCONTRACTOR'S REPORT

This report is required to be submitted to WMATA's DBE Office, 600 5th Street, NW, Suite 3C, Washington, DC 20001, pursuant to the requirements of WMATA's DBE Program Plan and 49 C.F.R. §26.29.

Contract No.: _____ Reporting Period: _____

Name of Subcontractor: _____ DBE – Yes or No

Subcontractor Contract Amount: _____ Total Received this Reporting Period: _____ Total Received to Date: _____

Name of Sub-Contractor	DBE (Y/N)	Description of Work	Date of Contract Awarded	Amount of Sub-Contractor Award	Amount Paid This Reporting Period	Cumulative Paid To Sub-Contractor	% of Physical Work Complete
TOTAL							

I certify the information furnished with respect to DBE subcontractor performance correct to the best of my knowledge and represents a current status for the designated period covered by this report. Further, those contractors, due payment pursuant to the terms of their subcontracts will be paid within ten days after receipt of payment from the Contractor.

By: _____ Title: _____ Date: _____

APPENDIX B-1

**NOTICE OF REQUIREMENTS
FOR
SMALL BUSINESS ENTERPRISE (SBE) PROGRAM**

May 2015

~Applies only if proposal price is \$500,000 or less.

SMALL BUSINESS ENTERPRISE PROGRAM (SBE)

SMALL BUSINESS ENTERPRISE PROGRAM (SBE) – DOES NOT APPLY TO THIS PROCUREMENT

SMALL BUSINESS PROGRAM POLICY

It is the policy of the Authority (WMATA), the Federal Transit Administration (FTA), and US Department of Transportation (USDOT) to foster small business participation in federally funded contracts. In order to facilitate competition and maximize participation by small businesses, the Authority will assign small business participation within the established threshold on a contract-by-contract basis on USDOT assisted construction and on non-construction procurements [i.e., contracts for services, supplies and equipment have a total value not to exceed five hundred thousand dollars (\$500,000.00).] The threshold may be satisfied by utilizing one (1) or more small business concerns as primes or subcontractors or suppliers of goods and services provided that the small business performs a minimum of fifty-one percent (51%) of the tasks pursuant to the awarded contract. The Contractor hereby agrees to carry out this policy in the award and administration of subcontracts to the fullest extent possible consistent with efficient Contract performance. Refer to Appendix B-1 for more detail on the SBE Program.

QUALIFICATIONS

- (a) A firm that is currently WMATA DBE certified under the Metropolitan Washington Unified Certification Program will automatically be certified as SBE. All other firms that meet the eligibility requirements must apply to the Authority's SBE Coordinator in the WMATA's DBE Program Office (DBEPO) for SBE status. All SBE certified firms will appear in the online WMATA SBE Directory.
- (b) A firm must be a small business as defined by the U.S. Small Business Administration (SBA) by applying current SBA business size standards found in 13 C.F.R. Part 121 that are applicable to the type of work the firm seeks to perform in USDOT-assisted contracts.
- (c) The firm's average gross receipts cannot exceed the overall USDOT size standard for a small business set forth in 49 C.F.R. § 26.65. [\$23.98 million averaged over the three (3) previous fiscal years or part of year which the business has been in existence].
- (d) At least fifty one percent (51%) of the firm's ownership must be held by individuals who meet the personal net worth (PNW) cap of \$1.32 million as prescribed by 49 C.F.R. § 26.67.
- (e) A firm must be organized for profit in order to be eligible for SBE certification.
- (f) The fifty one percent (51%) owner must be a U.S. Citizen or Permanent Resident.
- (g) **Each firm must be qualified as a SBE before the solicitation process. Proposals and bids will not be accepted from non-SBE qualified firms.**

CERTIFICATIONS

- (a) Each certified SBE firm that is a Non-DBE firm must annually submit an affidavit to WMATA's DBE Office affirming its continued eligibility to participate in the SBE program. SBE/DBE firms do not have to submit an affidavit annually as long as they stay in DBE compliance.

- (b) A firm seeking SBE certification and/or annual renewal must cooperate fully with WMATA DBE Office's requests for information relevant to the certification and annual renewal process. Failure or refusal to provide such information may result in the denial or removal of certification.

The SBE firm is responsible for listing the North American Industry Classification System (NAICS) Code(s) that is/are the primary activities of the business and ensuring the NAICS Code(s) have been approved by WMATA's SBE Coordinator.

Each SBE firm shall complete and adhere to all requirements in Appendix B-1.

~ APPENDIX B-1

SMALL BUSINESS ENTERPRISE (SBE) PROGRAM

1. SMALL BUSINESS ENTERPRISE (SBE) REQUIREMENT:

The SBE requirements of the Authority's DBE Program Plan apply to this contract. Accordingly, the Contractor shall carry out the requirements of the Authority's DBE Program Plan and this Appendix in the performance of this U.S. Department of Transportation (US DOT) assisted contract.

2. POLICY:

It is the policy of the Authority (WMATA), the Federal Transit Administration (FTA), and U.S.DOT to foster small business participation in federally funded contracts. In order to facilitate competition and maximize participation by small businesses, WMATA will assign small business participation within the established threshold on a contract-by-contract basis on USDOT assisted construction contracts and on non-construction procurements (i.e., contracts for services, supplies and equipment having a total value not to exceed \$500,000). The threshold may be satisfied by utilizing one (1) or more small business concerns as primes or subcontractors or suppliers of goods and services provided that the small business performs a minimum of fifty one percent (51%) of the tasks pursuant to the awarded Contract. The Contractor hereby agrees to carry out this policy in the award and administration of subcontracts to the fullest extent possible consistent with efficient Contract performance.

3. DEFINITIONS:

- A. **Appendix B-1.** The Notice of Requirements for Small Business Enterprise Program, when attached to a solicitation, implements the SBE requirements of the Authority's DBE Program Plan in the award and administration of federally funded Authority contracts.
- B. **Certified SBE.** Is a for-profit small business concern (a) that is at least fifty one percent (51%) owned by one or more individuals who are economically disadvantaged or, in the case of a corporation, in which fifty one percent (51%) of the stock is owned by one (1) or more such individuals; (b) whose management and daily business operations are controlled by one (1) or more of the economically disadvantaged individuals who own it; and (c) whose eligibility is evidenced by a current MWUCP (WMATA or D.C. Department of Transportation Certification letter), or an SBE certification letter issued by WMATA's DBE Office.
- C. **Contractor.** One who participates, through a contract or subcontract (at any tier), in a US DOT assisted highway, transit or airport program.
- D. **Commercially Useful Function (CUF).** An SBE performs a commercially useful function when it is responsible for execution of the work of the contract and is carrying out its responsibilities by actually performing, managing, and supervising the work involved. To perform a commercially useful function, the SBE must also be responsible, with respect to materials and supplies used on the contract, for negotiating price, determining quality and quantity, ordering the material, and installing (where applicable) and paying for the material itself. To determine whether an SBE is performing a commercially useful function, the Authority will consider the amount of work subcontracted, industry practices, whether the amount the firm is to be paid under the contract is commensurate with the work it is actually performing.

- (1) An SBE does not perform a commercially useful function if its role is limited to that

of an extra participant in a transaction, contract, or project through which funds are passed in order to obtain the appearance of SBE participation.

- (2) If an SBE does not perform or exercise responsibility for at least fifty one percent (51%) of the total cost of its contract with its own work force, or if the SBE subcontracts a greater portion of the work of a contract than would be expected on the basis of normal industry practice for the type of work, the Authority will presume that the SBE is not performing a commercially useful function.
- E. The following factors will be used by the Authority in determining whether an SBE trucking company is performing a commercial useful function:
- (1) The SBE must be responsible for the management and supervision of the entire trucking operation for which it is responsible for on a particular contract.
 - (2) The SBE must itself own and operate at least one fully licensed, insured and operational truck used on the contract.
 - (3) The SBE may lease trucks from another SBE firm, including an owner-operator who is certified as an SBE.
 - (4) The SBE may also lease trucks from a non-SBE firm, including an owner-operator. The SBE who leases trucks from a non-SBE is entitled to credit only for the fee or commission it receives as a result of the lease arrangement.
 - (5) The lease must indicate that the SBE has exclusive use of and control over the truck. This does not preclude the leased truck from working for others during the terms of the lease with the consent of the SBE, so long as the lease gives the SBE absolute priority for use of the leased truck. Leased trucks must display the name and identification number of the SBE.
- F. **DC DOT.** The District of Columbia Department of Transportation.
- G. **Economically Disadvantaged Individual.** Any individual who is a citizen (or other lawfully admitted permanent resident) of the United States and, in general, whose net worth is less than \$1.32 million (excluding equity in personal residence and applicant's firm).
- H. **Joint Venture.** An association of an SBE firm and one (1) or more other firms to carry out a single, for-profit business enterprise, for which the parties combine their property, capital, efforts, skills and knowledge, and in which the SBE is responsible for a distinct, clearly defined portion of the work of the Contract and shares in the capital contribution, control, management, risks, and profits of the joint venture commensurate with its ownership interest.
- I. **Metropolitan Washington Unified Certification Program (MWUCP).** A unified certification program mandated by 49 CFR §26.81 between two Federal transit recipients (WMATA and the D.C. Department of Transportation). The agreement became effective January 2005.
- J. **Race-conscious.** A measure or program that is focused specifically on assisting only DBEs, including women-owned DBEs.
- K. **Race-neutral.** A measure or program that is, or can be, used to assist all small businesses. For the purposes of the SBE and DBE programs, race-neutral includes gender-neutrality.

- L. **Small Business Concern.** With respect to firms seeking to participate as SBEs in US DOT assisted contracts, a small business concern as defined pursuant to Section 3 of the Small Business Act and Small Business Administration's implementing regulations (13 C.F.R. Part 121) that also does not exceed the cap on average annual gross receipts specified in 49 C.F.R. § 26.65(b).
- M. **US DOT Assisted Contract.** Any contract between the Authority and a contractor (at any tier) funded, in whole or in part, with US DOT financial assistance, including letters of credit or loan guarantees.
- N. **WMATA.** Washington Metropolitan Area Transit Authority, the transit system (rail and bus) serving the metropolitan Washington area, including parts of Virginia and Maryland.

4. SOLICITATION REQUIREMENTS:

The bidder shall submit the following with its bid or proposal, no later than the time of the bid or proposal due date. Any bidder who fails to complete and return this information with its bid shall be deemed to be not responsive and may be ineligible for contract award. Bidders that are not SBE certified shall be deemed to be not responsible and will be ineligible for Contract award.

- a. A copy of a current WMATA, D.C. DOT or MWUCP certification letter(s) or SBE certification letter shall be attached to evidence SBE pre-certification. All SBE firms must be pre-certified. Participation by a firm that is not currently certified as an SBE by the Authority at the time of bid opening does not count. All SBE firms must be in compliance with 49 CFR, Part 26.
- b. Information for Determining Joint Venture Eligibility, if applicable (Attachment 1, pgs. 1-4). Submittal shall be signed by all parties, dated and notarized.
- c. Copy of Joint Venture Agreement, if applicable. Submittal shall be signed by all parties, dated and notarized.
- d. Completed "Schedule of Participation for SBE Contracts" (Attachment 2) identifying the area of work and percentage of contract performance for SBE prime contractor and all subcontractors. The SBE must perform, at least fifty one percent (51%) of the total Contract value, to meet the SBE contract performance requirement.
- e. Executed "Letter of Intent to Perform as Subcontractor on SBE Contract" (Attachment 3) must be submitted for all subcontractors.

5. CONTRACT ADMINISTRATION REQUIREMENTS:

The following requirements apply after contract award:

- a. The Contractor shall include the following provision in each subcontract it awards:

"The contractor shall not discriminate on the basis of race, color, national origin or sex in the performance of this contract. The contractor shall carry out applicable requirements of 49 CFR Part 26 in the award and administration of U.S. DOT assisted contracts. The Contractor's failure to carry out these requirements is a material breach of this Contract, which may result in termination of this contract or such other remedy as the Authority deems appropriate."
- b. The Contractor shall report on SBE performance on the attached, SBE Prime Contractor Prompt Payment Report (Attachment 4) which shall be submitted monthly with each payment request. Failure to submit these report(s) may result in suspension of contract

payments. The Contractor shall certify, with each payment request, that payment has been or will be made to all subcontractors due payment, within ten (10) days after receipt of payment from the Authority for work by that subcontractor. The Contractor shall inform the COR or COTR, with its payment request, of any situation where scheduled subcontractor payments have not been made and the reason therefore. The Contractor shall require each subcontractor to complete and forward to the Small Business Coordinator on a monthly basis a "SBE Subcontractor Prompt Payment Report" (Attachment 5). The subcontractor shall certify that payment has been received.

- c. The Contractor must have the prior written approval of the contracting officer and the SBE office before substitution for an SBE subcontractor, regardless of the reason for substitution. Failure to obtain Authority approval could result in the Authority declaring the Contractor ineligible to receive further Authority contracts for three years from the date of the finding.
- d. The contractor shall forward copies of all subcontracts to the Small Business Coordinator at the time of their execution.
- e. If the Contracting Officer or other delegated Authority representative determines that the Contractor has failed to comply with this Appendix B-1, he/she will notify the Contractor of such noncompliance and the action to be taken. The Contractor shall, after receipt of such notice, take corrective action. If the Contractor fails or refuses to promptly comply, the Contracting Officer or other delegated Authority representative may issue a "stop work order" stopping all or part of the work, until satisfactory corrective action has been taken. No part of the time lost due to any such stop work order shall be made the subject of a claim for extension of time or for excess costs or damages by the Contractor. When the Authority proceeds with such formal actions, it has the burden of proving that the Contractor has not met the requirements of this Appendix, but the Contractor's failure to meet its Appendix B-1 goal shall shift to it, the requirement to come forward with evidence to show that it has met the good faith requirements of this Appendix.
- f. The Contractor agrees to cooperate in any studies or surveys that the Authority conducts which are necessary to determine the extent of the Contractor's compliance with this Appendix.
- g. The Contractor shall keep records and documents for three (3) years following performance of this Contract to indicate compliance with this Appendix. These records and documents, or copies thereof, shall be made available at reasonable times and places for inspection by any authorized representative of the Authority and will be submitted upon request together with any other compliance information that such representative may require.
- h. If the Authority, the FTA or the U.S. DOT has reason to believe that any person or firm has willfully and knowingly provided incorrect information or made false statements regarding the SBE Program, the matter shall be referred to the WMATA's DBE Office, and WMATA's Office of Inspector General (OIG).
- i. The Contractor's failure to carry out the requirements of this Appendix is a material breach of this Contract, that may result in the termination of this Contract or such other remedy as the Authority deems appropriate.

Information for Determining Joint Venture Eligibility

Page 1

.....

Name and address of Joint Venture:

Contact Person: _____ Telephone: _____

Have you attached a copy of the Joint Venture agreement? Yes No

NOTE: Affidavit will not be processed without a copy of the Joint Venture agreement.

.....

Name and address of Joint Venture partner: _____

Contact Person: _____ Telephone: _____

Status of firm: DBE Non-Minority Female Veteran.

Does firm have current WMATA, DC DOT or MWUCP DBE certification? Yes No

.....

Name and address of Joint Venture partner: _____

Contact Person: _____ Telephone: _____

Status of firm: DBE. Non-Minority Female Veteran.

Does firm have current WMATA, DC DOT or MWUCP DBE certification? Yes No

.....

Describe the nature of the Joint Venture business:

Describe the role in the Joint Venture of each partner listed above:

Describe the experience and business qualifications of each partner in the Joint Venture listed above:

Information for Determining Joint Venture Eligibility

Page 2

Indicate the percentage of ownership in the Joint Venture for each Joint Venture partner, indicating dollar amounts wherever applicable.

Name of Partner	Percentage of Ownership	Profit and Loss Sharing	Capital Contributions including Equipment	Other Agreements

TOTALS:

Identify by name, title, race, sex and company affiliation those individuals responsible for the management control of and participation in this contract:

1. Financial decisions, such as payroll, insurance, surety and/or bonding requirements:
Name: _____ Race: _____
Title: _____ Sex: Male Female
Company affiliation: _____
2. Management decisions, such as estimating, marketing and sales, hiring and firing, purchasing supplies:
Name: _____ Race: _____
Title: _____ Sex: Male Female
Company affiliation: _____
3. Supervision of field operations:
Name: _____ Race: _____
Title: _____ Sex: Male Female
Company affiliation: _____

M

Information for Determining Joint Venture Eligibility

Page 3

The undersigned swear that the foregoing statements are correct and include all material information necessary to identify and explain the terms and operations of our following named Joint Venture:

and the intended participation by each Joint Venturer in the undertaking. Further the undersigned covenant and agree to provide the Authority current, complete and accurate information regarding actual Joint Venture work and the payment thereof and any proposed changes in any of the Joint Venture arrangements and to permit the audit and examination of the books, records and files of the Joint Venture, or those of each Joint Venturer relevant to the Joint Venture, by authorized representatives of the Authority or the Federal funding agency. Any material misrepresentation will be grounds for terminating any contract that may be awarded and for initiating action under Federal and State laws concerning false statements.

It is recognized and acknowledged that the Authority's SBE Program shall have access to the information provided herein above for the purpose of establishing eligibility of the Joint Venture.

It is understood that trade secrets and information privileged by law, as well as commercial, financial, geological and geophysical data furnished will be protected.

(NAME OF FIRM) (NAME OF SECOND FIRM)

(SIGNATURE OF AFFIANT) (SIGNATURE OF AFFIANT)

(PRINT NAME) (PRINT NAME)

(TITLE) (TITLE)

(DATE) (DATE)

.....



Information for Determining Joint Venture Eligibility

.....

Date: _____ State: _____ County: _____

On this _____ day of _____, 20_____,

before me appeared _____

(Name)

to me personally known, who, being duly sworn, did execute the foregoing Affidavit, and did state that he or she was properly authorized by _____

(Name of Firm)

to execute the Affidavit and did so as his or her free act and deed.

(Seal) Sworn and subscribed before me _____
(Notary Public)

Commission Expires: _____

.....

Date: _____ State: _____ County: _____

this _____ day of _____, 20_____,

before me appeared _____

(Name)

To me personally known, who, being duly sworn, did execute the foregoing Affidavit, and did state that he or she was properly authorized by _____

(Name of Firm)

to execute the Affidavit and did so as his or her free act and deed.

(Seal) Sworn and subscribed before me _____
(Notary Public)

Commission Expires: _____

.....

SUBMIT WITH BID/PROPOSAL

SCHEDULE OF PARTICIPATION on SBE Contract

Contract No. _____

Project Name _____

Name of Bidder/Proposer

The bidder/proposer shall complete this Schedule by identifying those firms, (with scope of work and price), who have agreed to perform work on this Contract. The bidder/proposer agrees to enter into a formal agreement with the firm(s) listed for the work and at, or greater than, the prices listed in this Schedule subject to award of a Contract with the Authority.

Name of Subcontractor	Address	Type of Work (Electrical, Paving, Etc.) and Contract Items or Parts Thereof to be Performed and Work Hours Involved	Agreed Price
Subtotal \$ Subcontractors			
Name of Prime Contractor	Address	Type of Work (Electrical, Paving, Etc.) and Contract Items or Parts Thereof to be Performed and Work Hours Involved	Agreed Price
Subtotal \$ SBE Prime Contractor			
TOTAL \$ ALL CONTRACTORS		TOTAL	

Signature & Title of Contractor Representative **Date**

**LETTER OF INTENT TO PERFORM AS A SUBCONTRACTOR/JOINT VENTURE
(ALL ITEMS MUST BE COMPLETED)**

TO: _____
(Name of Bidder/Proposer)

The undersigned intends to perform work in connection with the above projects as (check one):

_____ An individual _____ A corporation
_____ A partnership _____ A joint venture

Specify in detail particular work items or parts thereof to be performed:

at the following price: \$ _____

Please indicate _____% of the dollar value of the subcontract that will be awarded to subcontractors, if applicable. The undersigned will enter into a formal agreement with you for the above work upon your execution of a contract with the Authority.

Name of SBE Firm's Subcontractor/Joint Venture

Phone Number

Address

WMATA Vendor ID

Signature & Title

Date

The following is to be completed by the Prime Contractor. A copy of this letter must be returned to the subcontractor to indicate acceptance.

To: _____
(Name of Subcontractor)

You have projected your interest and intent for such work, and the undersigned is projecting completion of such work as follows:

WORK ITEMS:

PROJECTED SUBCONTRACTOR COMMENCEMENT DATE:

PROJECTED SUBCONTRACTOR COMPLETION DATE:

(Name of Prime Contractor & Acceptance Signature) _____

WASHINGTON METROPOLITAN AREA TRANSIT AUTHORITY
SUPPLY AND SERVICE CONTRACT IFB-19023/GG
Washington Metropolitan Area Transit Authority (WMATA)

SMALL BUSINESS ENTERPRISE (SBE)
PRIME CONTRACTOR'S PROMPT PAYMENT REPORT

Page _____ of _____
 Reporting Period _____
 Contract Number _____

This Report is required to be submitted to the DBE Office, Attn: Coordinator, Small Business Programs, 8201 Ardwick Ardmore Road, Landover, MD 20785, pursuant to the requirements of WMATA's DBE Program Plan and 49 CFR Part 26.

Name of SBE Prime Contractor: _____

Prime Contract Amount: _____ :

Name of Sub-Contractor	SBE (Y/N)	Description of Work	Date Contract Awarded	Amount of Subcontractor Award	Amount Paid This Reporting Period	Cumulative Paid To Sub-Contractor

I certify the information furnished with respect to subcontractor performance is correct to the best of my knowledge and represents a current status of the SBE prime contractor with subcontractors for the designated period covered by this report. Further, those subcontractors, due payment pursuant to the terms of their subcontracts will be paid within ten (10) days after receipt of payment from WMATA.

Signature & Title of Authorized Representative: _____ Date: _____

Washington Metropolitan Area Transit Authority (WMATA)

**SMALL BUSINESS ENTERPRISE (SBE)
SUBCONTRACTOR'S PROMPT PAYMENT REPORT**

Page _____ of _____
 Reporting Period _____
 Contract Number _____

This Report is required to be submitted to the DBE Office, Attn: Coordinator, Small Business Programs, 8201 Ardwick Ardmore Road, Landover, MD 20785, pursuant to the requirements of WMATA's DBE Program Plan and 49 CFR Part 26.

Subcontractor: _____

SBE Prime Contractor: _____ Subcontract Amount: _____

Description of Service/Product Performed	Invoice Date	Invoice Amount	Payment Received From Prime Contractor (<i>Check # or EFT Confirmation #</i>)	Cumulative Payments Received From Prime Contractor

I certify that the information furnished with respect to payment(s) by the prime contractor for the above services/products is true and accurate to the best of my knowledge and belief.

Signature & Title of Authorized Representative: _____ Date: _____

ATTACHMENT A – DRAWINGS

ATTACHED HERETO

Silver Line Phase 2 Dulles Railyard
Warehouse and Rack Shelving Units Delivery and Installation

Attachment A – Drawings

(Building Facility Furniture and Equipment Layout Plans)

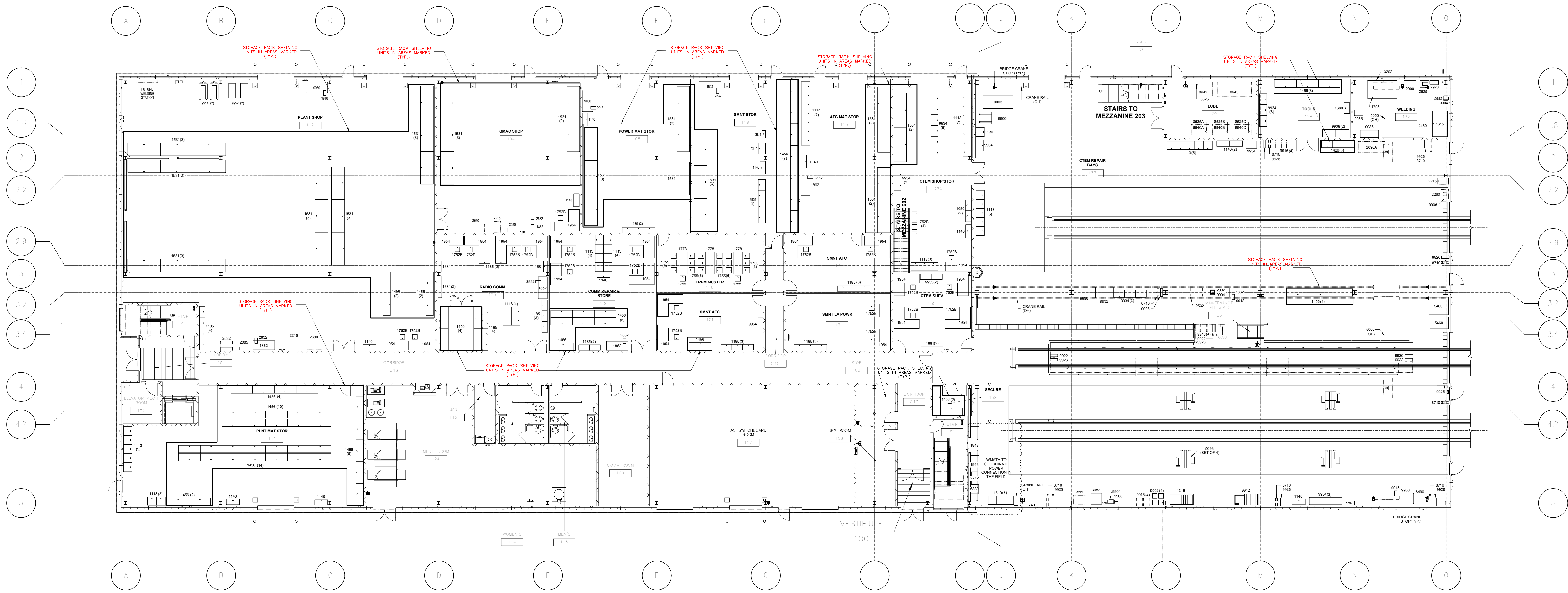

MAINTENANCE OF WAY BUILDING - FIRST FLOOR

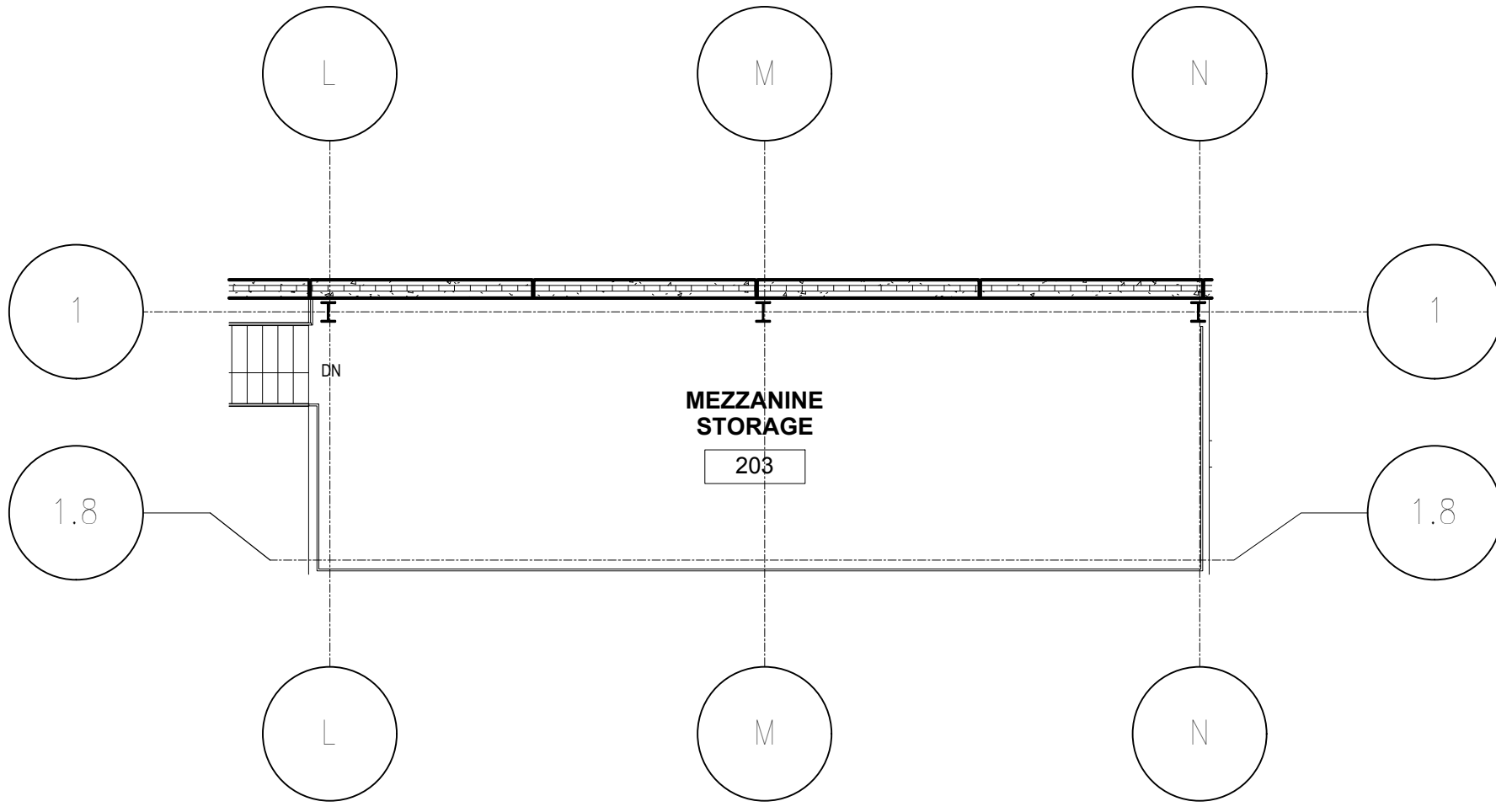
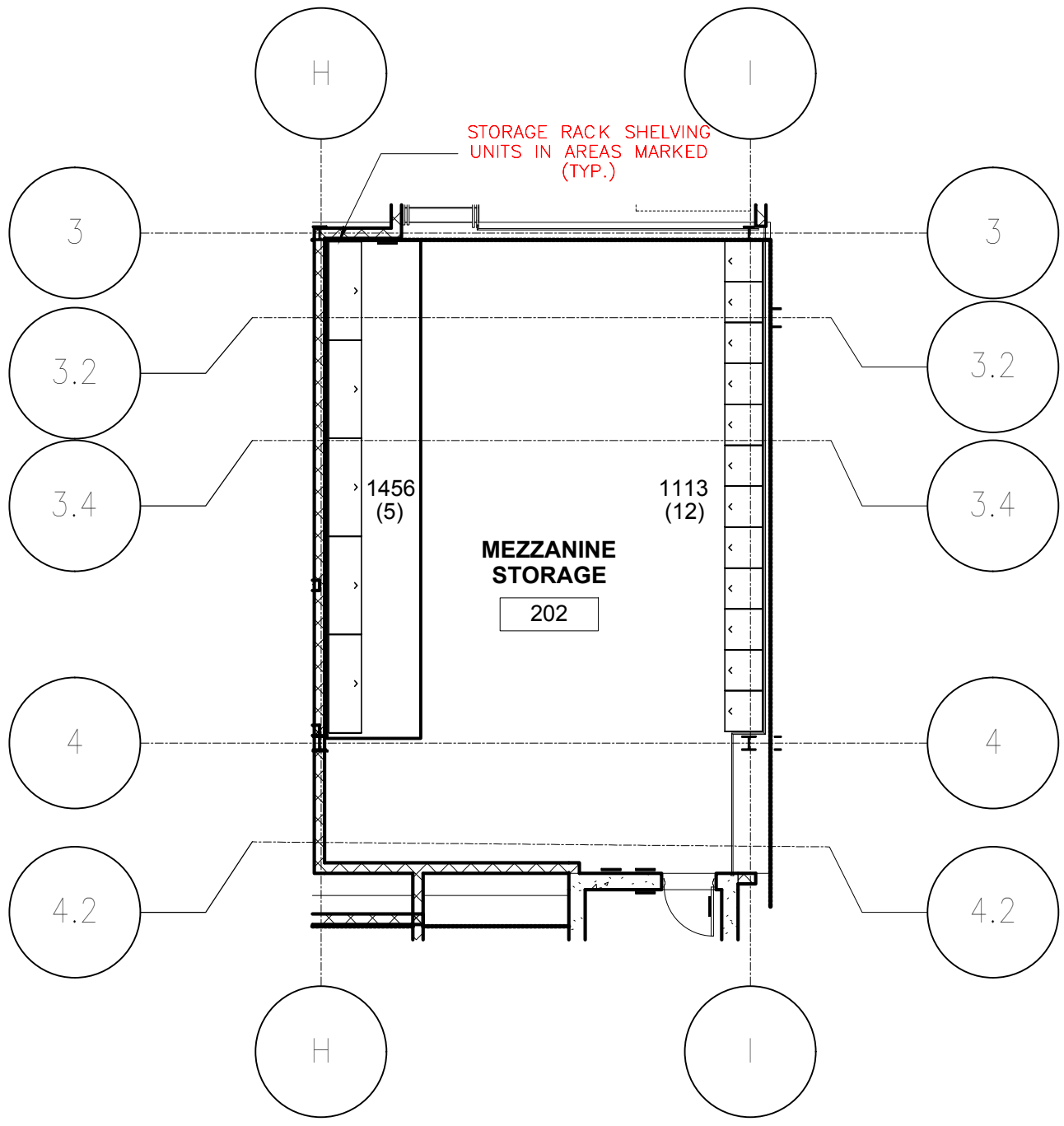

MEZZANINE

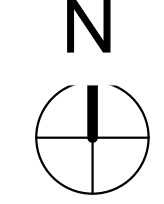

DESIGNED _____ DATE _____		REFERENCE DRAWINGS		REVISIONS		WASHINGTON METROPOLITAN AREA TRANSIT AUTHORITY		DULLES RAILYARD AND MAINTENANCE FACILITY					
DRAWN JA NAVARRO DATE 06/28/2018		NUMBER	TITLE	DATE	NUM	DESCRIPTION	MWB - WMATA FURNISHED EQUIPMENT LAYOUT PLAN		CONTRACT NO. 8-14-C001		SCALE NTS	DRAWING NO. N99-MWB-MP-900A	SHEET NO. SHEET 1 OF 1
CHECKED _____ DATE _____							REVISION SUBMITTED	DATE	APPROVED	DATE			

DRAWING SHEET NOTES

- 115V POWER AT THIS LOCATION AVAILABLE FOR REALLOCATION (INTENDED FOR TWO (2) 5776 - SCISSOR LIFTS). OUTLETS ON STUB UP FROM FLOOR (APPROXIMATE LOCATIONS). THESE WILL NEED TO BE PLACED AS CLOSE AS IT CAN BE TO 1776A TO ELIMINATE TRIPPING HAZARD.
- ROOMS 114, 116, 118A - FURNITURE IN THESE ROOMS ARE INCLUDED AS PART OF THE ADMINISTRATIVE OFFICE FURNITURE PACKAGE.
- EQUIPMENT WILL BE CHANGED TO A RENTED VENDING EQUIPMENT (FASTENAL).
- LIFT EQUIPMENT PARKING/CHARGING AREA
- 4350 - AXLE INSPECTION MACHINE FURNISHED BY END USER

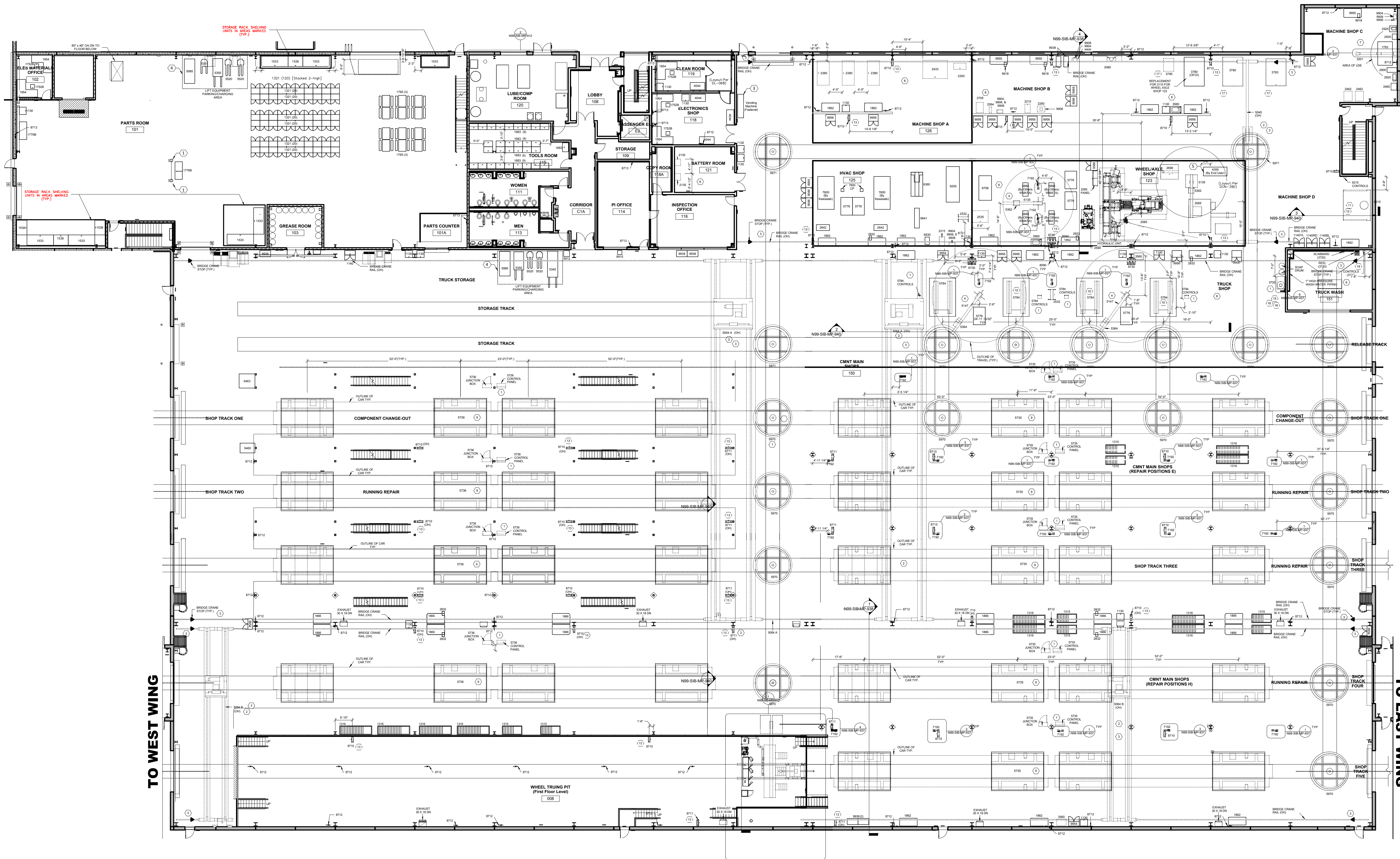

SIB - OVERALL EQUIPMENT LAYOUT PLAN
N99-SIB-MP-900A

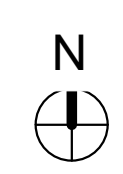

DESIGNED	DATE	REFERENCE DRAWINGS		REVISIONS		
		NUMBER	TITLE	DATE	NUM	DESCRIPTION
DRAWN	JA NAVARRO	06/28/2018		02/20/2017	0	Issued for Permit
CHECKED				11/20/2017	1	Equipment Layout Modification
				06/28/2018	2	Issued for WMATA Furnished Equipment Procurement

WASHINGTON METROPOLITAN AREA TRANSIT AUTHORITY

REVISION SUBMITTED _____ DATE _____ APPROVED _____ DATE _____

DULLES RAILYARD AND MAINTENANCE FACILITY			
SIB - WMATA FURNISHED EQUIPMENT LAYOUT PLAN			
CONTRACT NO.	SCALE	DRAWING NO.	SHEET NO.
8-14-C001	NTS	N99-SIB-MP-900A	SHEET 1 OF 1

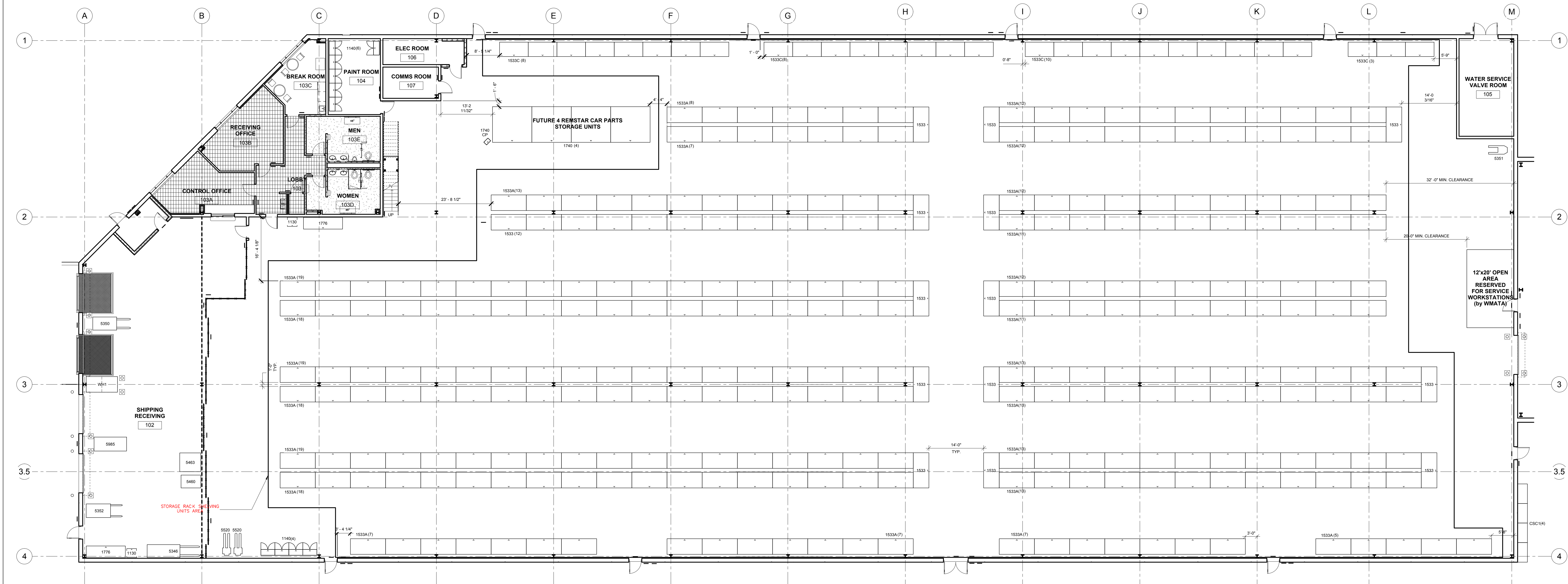

1 WHB - OVERALL EQUIPMENT LAYOUT PLAN
N99-WHB-MP-900A

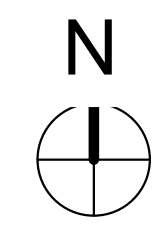

DESIGNED	DATE	REFERENCE DRAWINGS		REVISIONS		
		NUMBER	TITLE	DATE	NUM	DESCRIPTION
DRAWN	JA.NAVARRO	06/28/2018	DATE	02/20/2017	0	Issued for Permit
				05/14/2018	1	Equipment Layout Modification
CHECKED	DATE	06/28/2018	2	Issued for WMATA Furnished Equipment Procurement		

M metro WASHINGTON METROPOLITAN AREA TRANSIT AUTHORITY

REVISION SUBMITTED _____ DATE _____ APPROVED _____ DATE _____

DULLES RAILYARD AND MAINTENANCE FACILITY			
WHB - WMATA FURNISHED EQUIPMENT LAYOUT PLAN			
CONTRACT NO. 8-14-C001	SCALE NTS	DRAWING NO. N99-WHB-MP-900A	SHEET NO. SHEET 1 OF 1

ATTACHMENT B - WAREHOUSE AND RACK SHELVING REQUIREMENTS MANUAL

ATTACHED HERETO

**Silver Line Phase 2 Dulles Railyard
Warehouse and Rack Shelving Units Delivery and Installation**

Attachment B - Warehouse and Rack Shelving Requirements Manual



Washington Metropolitan Area Transit Authority

DULLES SILVER LINE PHASE 2
RAIL YARD AND MAINTENANCE FACILITY

WAREHOUSE AND RACK SHELVING REQUIREMENTS MANUAL

Dulles Silver Line – Phase 2

July 3, 2018

Warehouse and Rack Shelving Schedule

Description	Quantity
MWB	112
1420 - RACK, ARM, SINGLE FACE, 7 ARM LEVELS, 7 FEET HIGH	3
1456 - RACK, BULK STORAGE, SOLID DECK	71
1531 - RACK, PALLET, 42 INCHES DEEP, 12 FEET TALL, SOLID DECK	38
SIB	11
1533 - RACK, PALLET, 42 INCHES DEEP, 16 FEET TALL, WIRE DECK	7
1538 - RACK, PALLET, 42 INCHES DEEP, 16 FEET TALL, WIRE DECK	4
WHB	328
1533 A - RACK, PALLET, 48 INCHES DEEP, 16 FEET TALL, WIRE DECK	299
1533 C - RACK, CANTILEVER, HEAVY DUTY, SINGLE SIDED, 3 ARM LEVELS, 12 FEET	29
Grand Total	451

Storage Rack Shelving Units Cutsheets/Specifications

1420 Equipment Cutsheet

Equipment Description:					ID No.
Rack, arm, single face, 7 foot high					1420
Basis of Design (Model No.)	Lyon Workspace (3700 Single-Face Rack, with starter and add-on)	Dimensions	Length (inches)	Width (inches)	Height (inches)
			36	22	79.25
Facility	MWB	Operational Clearance	Left: 12	Front: 12	Above: -
Features:			Right: 12	Back: -	Below: -
<ul style="list-style-type: none"> a. Number of levels: 21 b. 12" Deep Arms Capacity: 450 lbs. c. Adjustable arms every 1-1/2" d. Brace panels and cross braces included 					

1456 Equipment Cutsheet

Equipment Description:					ID No.
Rack, bulk storage, deck					1456
Basis of Design (Model No.)	Equipto (1028W62S starter and 1028W62A)	Dimensions	Length (inches)	Width (inches)	Height (inches)
			72	24	96
Facility	MWB	Operational Clearance	Left: -	Front: 72	Above: 48
Features:			Right: -	Back: 6	Below: -
<ul style="list-style-type: none"> a. Four level bulk rack with solid decking b. Made of solid 3-1/2" beams c. Solid Corrugated Steel Decking Capacity (6'x24") : 2,778 lbs (<i>no wire decking</i>) 		<div style="display: flex; justify-content: space-around; margin-bottom: 10px;"> <div style="border: 1px solid black; padding: 2px 10px;">Starter</div> <div style="border: 1px solid black; padding: 2px 10px;">Add-on</div> </div> 			

1531 Equipment Cutsheet

Equipment Description:					ID No.
Rack, pallet, 42 inches deep, 12 feet tall					1531
Basis of Design (Model No.)	Lyon Workspace (Uprights: U3614442, Beams: B6500108)	Dimensions	Length (inches)	Width (inches)	Height (inches)
			108	42	144
Facility	MWB	Operational Clearance	Left: -	Front: 48	Above: 24
Features:			Right: -	Back: 6	Below: -
<ul style="list-style-type: none"> a. Min. Beam Load Capacity: 5,000 lbs. b. Four Upper Beam Levels c. Heavy Duty Upright: 3" x 3", 13 gauge d. Solid decking: Heavy 14-gauge panels feature 3" x 1-5/8" x 14-gauge hat channels welded to the underside. 					

1533 Equipment Cutsheet

Equipment Description:					ID No.
Rack, pallet, 42 inches deep, 16 feet tall					1533
Basis of Design (Model No.)	Lyon Workspace (Uprights: U2619242, Beams: B6500108, Wire Decking)	Dimensions	Length (inches)	Width (inches)	Height (inches)
			108	42	192
Facility	SIB	Operational Clearance	Left: -	Front: 48	Above: 24
Features:			Right: -	Back: 6	Below: -
<ul style="list-style-type: none"> a. Min. Beam Load Capacity: 5,000 lbs. b. Three Upper Beam Levels c. Heavy Duty Upright: 3" x 3", 13 gauge d. Wire decking: Heavy duty 2-1/2" x 4" x 6-gauge wire mesh with 14-gauge steel channels 					

1533A Equipment Cutsheet

Equipment Description:					ID No.
Rack, pallet, 48 inches deep, 16 feet tall					1533A
Basis of Design (Model No.)	Lyon Workspace (Uprights: U2619242, Beams: B6500108, Wire Decking)	Dimensions	Length (inches)	Width (inches)	Height (inches)
			108	48	192
Facility	WHB	Operational Clearance	Left: -	Front: 48	Above: 24
Features:			Right: -	Back: 6	Below: -
<ul style="list-style-type: none"> a. Min. Beam Load Capacity: 5,000 lbs. b. Three Upper Beam Levels c. Heavy Duty Upright: 3" x 3", 13 gauge d. Wire decking: Heavy duty 2-1/2" x 4" x 6-gauge wire mesh with 14-gauge steel channels 					

1533C Equipment Cutsheet

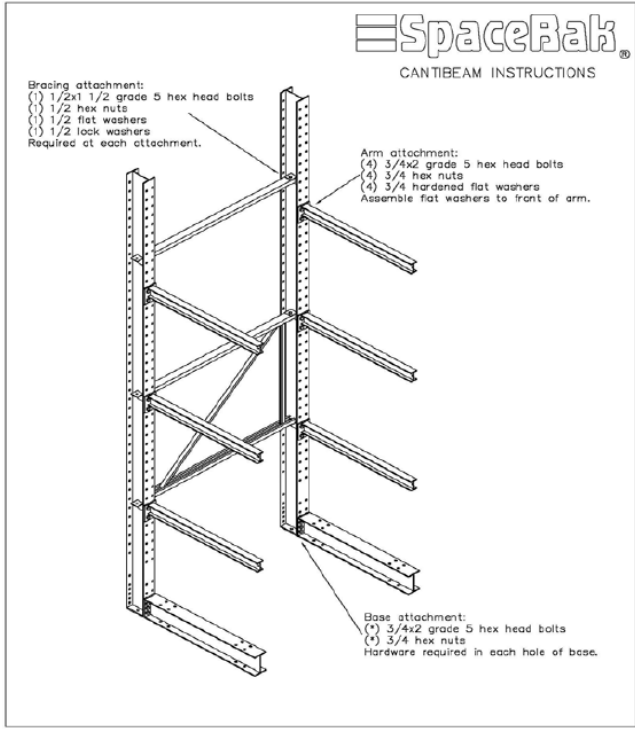
Equipment Description:					ID No.
Rack, cantilever, heavy duty, single sided, 12 feet					1533C
Basis of Design (Model No.)	Lyon Workspace (Space-Rak)	Dimensions	Length (inches)	Width (inches)	Height (inches)
			72	36	144
Facility	WHB	Operational Clearance	Left: -	Front: 108	Above: 12
Features:			Right: -	Back: 6	Below: -
<ul style="list-style-type: none"> a. Single faced rack unit b. Heavy duty 12'ft high, 36" arms c. 12' high units supplied with 3 arms per upright d. Upright Capacity: 13,800 lbs. e. Arm Capacity: 2,240 lbs. f. Arms are adjustable on 4" centers g. Consist of upright frames, arms, and brace set kits and accessories. 		 <p style="text-align: right;">SpaceBak CANTIBEAM INSTRUCTIONS</p> <p>Bracing attachment: (1) 1/2x1 1/2 grade 5 hex head bolts (1) 1/2 hex nuts (1) 1/2 flat washers (1) 1/2 lock washers Required at each attachment.</p> <p>Arm attachment: (4) 3/4x2 grade 5 hex head bolts (4) 3/4 hex nuts (4) 3/4 hardened flat washers Assemble flat washers to front of arm.</p> <p>Base attachment: (4) 3/4x2 grade 5 hex head bolts (4) 3/4 hex nuts Hardware required in each hole of base.</p>			

1538 Equipment Cutsheet

Equipment Description:					ID No.
Rack, pallet, 42 inches deep, 16 feet tall					1538
Basis of Design (Model No.)	Lyon Workspace (Uprights U3614442, Beams B6356060, Wire Decking)	Dimensions	Length (inches)	Width (inches)	Height (inches)
			60	42	192
Facility	SIB	Operational Clearance	Left: -	Front: 48	Above: 24
Features:			Right: -	Back: 6	Below: -
<ul style="list-style-type: none"> a. Min. Beam Load Capacity: 5,000 lbs. b. Three Upper Beam Levels c. Heavy Duty Upright: 3" x 3", 13 gauge d. Wire decking: Heavy duty 2-1/2" x 4" x 6-gauge wire mesh with 14-gauge steel channels 					

ATTACHMENT C – SAFETY, SECURITY, ACCESS

ATTACHED HERETO

ATTACHMENT C – SAFETY, SECURITY & ACCESS TO THE SITE

1. Pre-Mobilization Requirements

a. Pre-Installation Conference

One to two weeks prior to each mobilization, the Contractor and any subcontracted installer(s) shall participate in a Pre-Installation Conference. The Conference Agenda will include:

- Job-Site Orientation
- Work Hours & Delivery Scheduling
- Rules of the Site
- AHA and Job Site Hazards review
- PPE & other requirements for work on the site.

b. Required Safety Training – Dulles Yard

- All employees must attend the Hensel Phelps safety training and orientation. This will require a 3-hour commitment for each employee for this training prior to starting work onsite.
- At least one 30-hour OSHA Trained employee must be onsite at all work times
- All other trade workers are 10-hour OSHA Trained.

2. Working Hours

The standard work week shall be five days, Monday through Friday. The time shall be 7:00 AM to 3:30 PM, with lunch period from 12:00 PM to 12:30 PM. Work hours outside the standard work week shall be coordinated through the WMATA Project Manager with Project Site Superintendent.

3. Delivery & Handling

All deliveries to the site will be scheduled a minimum of 48 hours in advance. Labor and equipment for unloading deliveries, will be the Contractor's responsibility. Unscheduled deliveries may be rejected.

Deliveries shall occur between the hours of 7:00 AM and 3:30 PM Monday through Friday.

Deliveries must be accompanied by a bill of lading, which shall include the following information:

- Contractor's Name (or name of Subcontractor receiving the material.)
- Name and telephone number of Contractor's representative to contact at the jobsite
- A complete listing of all materials/equipment that is to be delivered.

All materials shall be palletized and/or containerized, to the greatest extent possible. The Contractor is responsible to have suitable equipment for offloading and delivering materials to the point of installation onsite at all times for distribution of their material. Neither WMATA nor the Design Builder will loan or rent equipment to subcontractors.

4. Employee Parking

Employee parking will be provided on site at designated areas as determined by WMATA and/or the Design Builder. No employee vehicles will be allowed within the construction area. Company vehicles, that are owned or leased by the Contractor, subcontractors, or suppliers, and are necessary for the work, will be allowed access into the construction area. Vehicles parked in loading areas shall be relocated to designated parking areas, after off/loading activities are complete.

5. Safety & Security

Contractors working in an active railyard construction site, which the Design Build Contractor (Hensel Phelps Construction Company) still manages, must sign in and out and be escorted. The Contractor's installation crew, subcontractors, and suppliers will be required to observe all safety requirements for access to the Dulles railyard site and will be subject to the requirements of Hensel Phelps Safety & Health Plan. This includes escorts and all safety training required to deliver materials to the locations indicated in the plans.

6. Personal Protective Equipment (PPE)

All Contractor's employees will be required to wear appropriate PPE all and at all times when at the job site, including:

- Class III reflective safety vests, work boots with safety toe, safety eye protection, gloves and hard hat with Safety Training Sticker.

7. Protection of Installed Products

a. Materials Handling Plan

The Contractor shall provide a Materials Handling Plan including description of the following provisions:

- Protect the existing finishes when delivering and installing the rack and shelving.
- Plan for daily disposal of packaging materials.

b. Protection of Installed Work/Finishes

Protect the existing finishes when delivering and installing the rack shelving. The Contractor shall remove and dispose all temporary protective materials used during installation. The Contractor shall be responsible to pay for all costs of any damages created by the installation work crew in the course of delivery and installation of their work.

8. Clean Up

The Contractor shall remove from their work area(s) all debris, cartons, crates, boxes, and general waste generated by their work and their employees or lower-tier subcontractors at the end of each day or as work is completed. Such debris and waste shall be deposited daily by the Contractor to an appropriate dumpsters provided and paid for by the Contractor, or removed from site in the vehicle used for the initial material delivery.

9. Specific Safety Submittals

a. Prior to Start-up

- Contractor's Safety Program
- SDS's for all hazardous material that will be brought onsite and SDS Log
- Completed AHAs
- List of Competent Persons on Site
- Employee Training Documentation (ex. If forklifts are used, operators must be trained.)
- Emergency Contact List

b. Periodic Submissions

- Accident or Near Miss Investigation Reports (as required)
- AHAs for New/Modified Tasks Copies of AHAs signed by all employees verifying training on the AHAs

10. Activity Hazard Analysis (AHA)

The Contractor will be required to submit an (AHA) at least one week prior to the commencement of any activity to WMATA. The approved AHA must be reviewed and signed, acknowledging training and acceptance by the individual crewmembers performing the tasks discussed in the AHA. When new employees come on board or are assigned to an on-going task, it is the

Contractor's responsibility to ensure that the new employees are trained on the AHAs for those activities. Once this training is completed, these new employees shall sign the AHA and a new copy of the AHA shall be forwarded to WMATA.

Periodically (at least monthly) throughout the duration of the project, the Contractor shall retrain all employees on the appropriate AHA to ensure that the employees are continuously reminded of the hazards of their work and the safeguards that are in place to prevent accidents and/or injuries. Documentation of retraining shall be forwarded to WMATA.

11. Safety Plan Policies Specific to the Installation of Work on the Dulles Yard during the Construction Phase

a. Yard Design Builder's Safety & Health Plan

It is the policy of Hensel Phelps (HP) to perform work in the safest manner possible consistent with good construction practices. To fulfill the requirements of this policy, an organized and effective safety and health program must be carried out at each location where work is performed. Furthermore, it is HP's philosophy to make safety equal in importance to quality, schedule, cost, and production.

It is HP's policy that accidents can be prevented through planning, training, and a cooperative effort in all areas of their operations. In an effort to prevent death, injury, and unnecessary hazard to employees and to the public, loss of production, time, and damage to equipment, Hensel Phelps has established a job specific Safety & Health Plan for this project. A copy of this plan will be provided by MWAA's Safety Manager via WMATA on-site representatives. All employees working on the site are required to comply with this plan without exception.

b. Contractor's Safety & Health Plan

The Dulles Yard Contractor Rack Shelving Installer shall be responsible for compliance with the safety provisions of the Warehouse and Rack Shelving Contract, MWAA Rev 16 Safety Manual, the Hensel Phelps's Project Safety & Health Plan, and all relevant VOSH and OSHA regulations. The Contractor shall be responsible for initiating, maintaining and supervising all safety precautions and programs in connection with the work, and supervise all reasonable protection to prevent damage, injury or loss to: 1) their employees, the employees of their subcontractors, and all other persons, 2) all work, including all materials and equipment to be incorporated therein, and 3) all property at the site or adjacent thereto.

Prior to mobilization on-site, the Contractor or designated Installer shall submit to WMATA a written Safety Plan or a copy of the company's safety program and activity hazard analysis for each activity. The Contractor shall submit the name of the individual who is responsible for the implementation of the safety plan or program. This individual must have authority to direct jobsite foremen and superintendents to comply with company directives. In addition, the Contractor shall comply with the approved project specific safety plan. All employees must attend the Hensel Phelps safety training and orientation.

c. Specific Safety Training

The Dulles Yard Project requires OSHA Construction Certifications. All supervisory personnel must be 30-hour OSHA trained and that all other trades workers are 10-hour OSHA trained. Proof of these certifications must be submitted to WMATA prior to the Pre-Installation Conference. At least one 30-hour OSHA Trained employee must be on-site during all work times.

Prior to commencing work in the Dulles Yard, all employees shall attend the Site-Specific Safety Training for the Dulles Yard Construction Project. The Contractor Installer should plan on a 2-hour commitment for each employee for this training prior to starting work onsite. The Site-

Specific Safety Training will include, but not be limited to: 1) Orientation to the Project and safety policies, and 2) Orientation to basic rules of conduct for onsite operations.

Upon completion of this training all employees will be issued a hardhat sticker that must be kept on their hardhat and readily visible at all times, along with their full name on the front of their hardhat. These stickers are used by Hensel Phelps to identify the individual in the event of an accident, special medical conditions and emergency contact. Failure to obtain or display this hardhat sticker may be grounds for immediate removal from the Project.

d. OSHA Construction Certifications

Ensure all supervisory personnel are 30-hour OSHA Trained and all other trade workers are 10-hour OSHA Trained. These Certifications must be obtained prior to starting work onsite. At least one 30-hour OSHA Trained employee must be onsite at all work times.

e. Fall Protection Plan

For all work at heights above 6 feet, submit a detailed site-specific Fall Protection Plan. Comply with the most stringent OSHA requirements for Walking-Working Surfaces (29 CFR Part 1910 Subpart D), Scaffolds (29 CFR Part 1923, Subpart L), and Fall Protection (29 CFR Part 1926, Subpart M).

f. Zero Tolerance Safety Violations Policy

While working on an active construction site, the Contractor and its employees will abide by the Design-Build Contractor's zero tolerance policy in effect at all times for the following:

1. Hardhat and safety glasses will be mandatory at all times while on the jobsite. First offense a warning notice will be issued and the employee will be removed from the jobsite for the balance of the day, and the following day. Second offense the employee may be removed from the jobsite permanently, at the discretion of Design-Build Contractor and/or WMATA's designated on-site manager.
2. Any employee in violation of the Substance Abuse Policy will be removed from the jobsite permanently.
3. Any employee in possession of a weapon will be removed from the jobsite permanently.
4. Any employee engaged in fighting, inflicting bodily harm against others, or physically/verbally threatening others will be removed from the jobsite permanently, at the discretion of Design-Build Contractor and/or WMATA Project Manager.
5. Any employee engaging in a situation deemed as one of imminent danger will be removed from the jobsite permanently, at the discretion of the Design-Build Contractor and/or WMATA Project Manager.

First offense violations of items "1", "4", and "5" above will also require the employee, foreman, and superintendent to attend a remedial orientation session the day the employee returns to the jobsite.

g. General Rules of Conduct

1. *Safety shall be given the highest priority.*
2. *Conform to all safety rules, signs and regulations.*
3. *Hard hats, vests, and safety glasses shall be worn at all times.*
4. *Adequate clothing and work boots will be worn at all times.*
5. *Report every accident or near miss immediately, no matter how slight. Copies of all accident or near miss reports are to be forwarded to WMATA within 24 hours of the accident or near miss.*
6. *Horseplay on the job will not be tolerated.*
7. *Do not operate any machine or equipment without authority, licensing, and training.*
8. *Be sure machine guards are in position before starting the machine.*

9. *Good housekeeping is required at all times.*
10. *Under no conditions will drugs or alcohol be carried or consumed on the job. Anyone reporting for work under the influence of or carrying drugs or alcohol will be discharged immediately and removed from the jobsite.*
11. *Work clear of suspended loads.*
12. *Obey warnings on tags and signs. They are posted for the employee's protection.*
13. *Watch for and report all safety hazards.*
14. *Watch for and report all fire hazards.*
15. *No guns, knives, explosives, or other weapons allowed onsite.*
16. *No personal radios or ear buds/headphones are allowed onsite.*
17. *Break areas will be designated by the On-Site Project Superintendent (either Hensel-Phelps or WMATA.)*
18. *Use of tobacco products such as smoking, chewing tobacco, or snuff will not be permitted in or on the roofs of any on-site buildings at any time.*

h. Safety Meetings

All Contractors are required to hold a tool box safety meeting at least once weekly and make a record of the meeting on Hensel Phelps' Weekly Safety Meeting Report. The original copy of the agenda and meeting notes will be transmitted to WMATA and Hensel Phelps' superintendent for review and filing in the Contractor's safety file. An attendance sheet of employees who attended the safety meeting shall be included with the meeting notes. In addition, Contractors are required to attend a weekly job-wide Safety Meeting to be held onsite at 7:00am on Mondays.

i. First Aid or Emergency Medical Treatment

1. The Contractor shall assign a Category II individual to perform the duties of Safety Superintendent and First Aid Attendant. Category II means that the Safety Superintendent may be the project foreman or an employee who is on-site at all times while work is being performed, and who has the added duty of supervising the safety of persons, equipment, and property affected by contract work. One individual may combine the functions of a First Aid Attendant and Safety Superintendent. The Safety Superintendent and First Aid Attendant shall be responsible for First Aid and CPR at the site and must have current First Aid and CPR certificates. If, at any time, the work site is without the services of an approved Safety Superintendent and First Aid Attendant for a period of 15 calendar days or more, the work may be closed down at the discretion of WMATA's Representative. The Safety Superintendent must be acceptable to WMATA's Representative and his/her performance will be reviewed and documented by WMATA's Representative on a continuing basis. If the Safety Superintendent's effectiveness is below standard, the Contractor shall provide immediate replacement at the WMATA Representative's direction. Once employed, the Safety Superintendent shall not be changed without permission of WMATA's Representative. A resume must be submitted documenting the education and experience of the individuals assigned to perform the duties of Safety Superintendent.
2. In the event of an accident and/or injury to an employee, the Contractor shall immediately determine if the employee needs only first aid or emergency medical treatment. For first aid treatment, administer first aid and transport the employee to the MWAA jobsite trailer if assistance is needed. If emergency medical treatment is necessary, contact WMATA's on-site manager to report an injury. If incident is life threatening or a fire is out of control Dial 911 and direct first responders to the Hensel Phelps project located at Dulles Rail and Shop. Have a second person notify WMATA and the MWAA Safety Officer immediately by calling or going directly to the jobsite trailer. Do not move the injured person unless they are in danger of additional injuries. Keep the injured person comfortable until emergency medical personnel arrive at the jobsite.

j. Accident or Near Miss or Near Miss Reporting

Report every accident or near miss immediately, no matter how slight. Conduct a thorough investigation of the accident or near miss including interviewing all witnesses. Within 24 hours of the accident or near miss forward a copy of the accident or near miss investigation form to WMATA and the MWAA's Safety Officer.

k. Emergency Action Plan

Hensel Phelps has developed a project specific Emergency Action Plan to be used in the event of a major injury or evacuation. The Contractor should familiarize himself with this plan and locations to be used as rally points. This Emergency Action Plan will be reviewed with all workers at the Site-Specific Safety Training conducted on site so that all employees are familiar with the plan. Please contact Hensel Phelps' Project Superintendent with any questions on this plan. Copies of the plan are posted in the Hensel Phelps jobsite trailer.

l. Employee Indoctrination

All employees of Hensel Phelps and all jobsite Contractors will undergo an orientation briefing before they begin work on this project. The briefing will include the following information:

- Safety Policies
- Project Specific Security Policies
- Review of project prohibited items
- Gang boxes at work areas will be provided by Contractors for storage or personal and company tools as needed and coordinated with Hensel Phelps.
- Radio (music) will not be allowed any time on this site.
- Zero tolerance will be exercised for written, verbalized, or gestured derogative sexual, ethnical, or racial harassments or remarks at all times on the jobsite.

m. Site Access

Every employee will be issued a badge/sticker, certifying that they went through the required safety orientation prior to starting work. This badge/sticker must be worn at all times and visible while on the jobsite.

n. Communications

It is strongly encouraged that all Contractors have a work cell phone to allow for optimum coordination between the project team.

o. Photos

This is security sensitive project, use of photographic or video equipment is not allowed on this project. Subcontract may request monthly progress photos from the contractor.

p. Prohibited Items

The following items are prohibited on the project site:

- Alcohol
- Controlled Substances
- Weapons
- Radios, walkmans, iPods, headphones, ear buds, etc.
- Cameras
- Cooking devices such as hot plates, open flame burners, etc

ATTACHMENT D - MAP VIEW OF THE SITE VISIT LOCATION

ATTACHED HERETO

Dulles Metrorail Yard Construction Trailer – MWA/WMATA Site Office
44259 Old Ox Road, Sterling, VA 20166

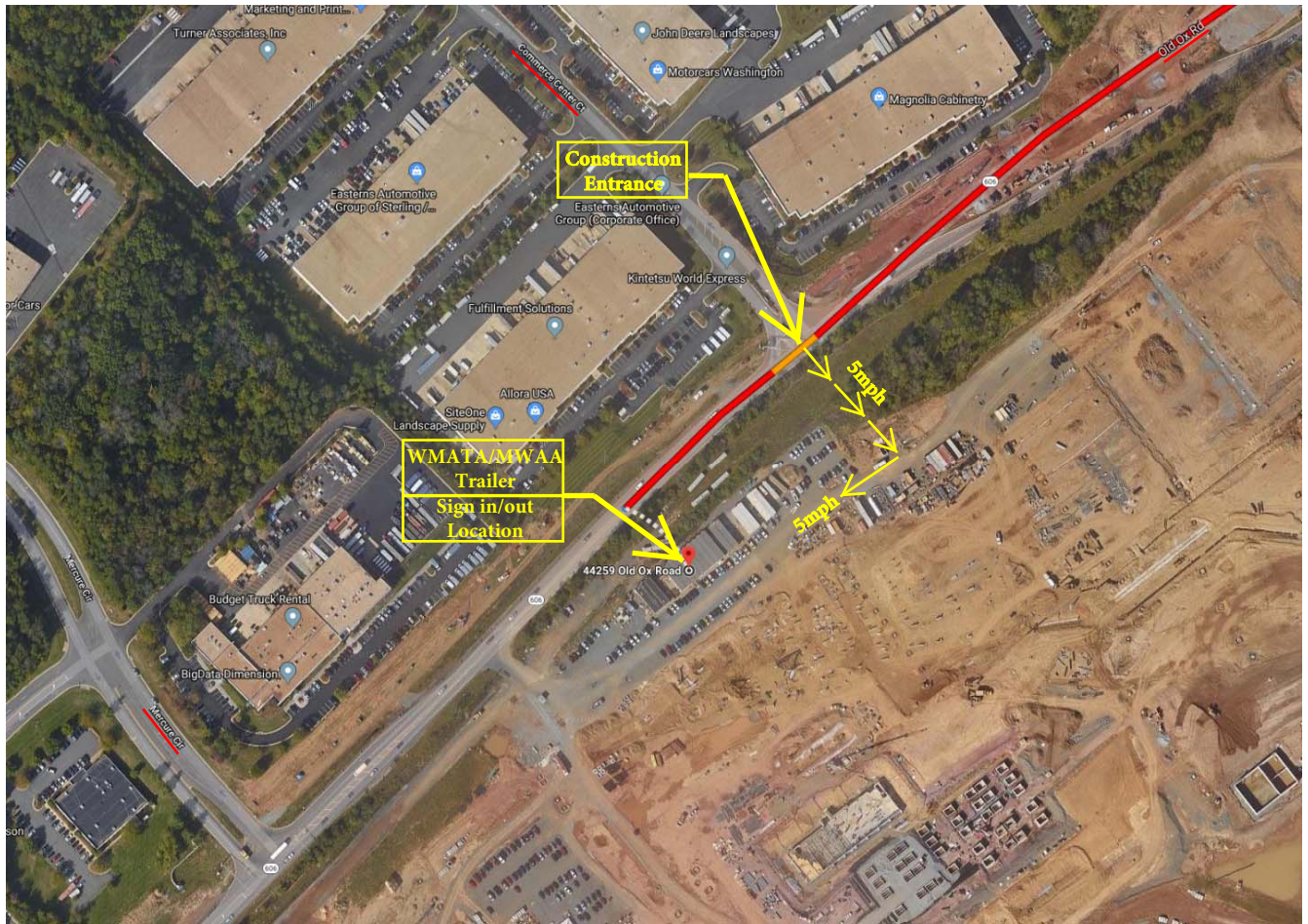

COMBINED GLOSSARY OF DEFINITIONS

As used throughout this Contract, except to the extent otherwise expressly specified, the following terms shall have the meanings set forth below:

Acceptance: Acknowledgment by the Authority that the supplies, services, or other work conform to the applicable contract requirements.

Acceptance Period: The number of days available to the Authority to award a Contract pursuant to this solicitation, during which period offerors may not withdraw their offers.

Amendment: Written instructions issued prior to the date set for bid opening to clarify, revise, add or delete requirements of the IFB.

Approved equal: An item approved by WMATA as equivalent to a brand name item originally specified.

Authority or WMATA or Metro: The Washington Metropolitan Area Transit Authority, created effective February 20, 1967, by Interstate Compact by and between Maryland, Virginia and the District of Columbia pursuant to Public Law 89-774, approved November 6, 1966.

Board of Directors: The Board of Directors of the Washington Metropolitan Area Transit Authority.

Brand name: Identification of an item that is produced or controlled by one or more entities, including trademarks, manufacturer names, or model names or numbers that are associated with a manufacturer.

Breach: An unexcused and unjustifiable failure or refusal of a party to satisfy one (1) or terms of the Contract which, if material, shall constitute a basis for potential default.

Change or Change Order: A written alteration issued, upon agreement of both parties or unilaterally by the Authority, to modify or amend the Contract, generally directing changes to the Scope of Work and/or Contract terms.

Claim: A written demand or assertion by the Contractor seeking, as a legal right, the payment of money, adjustment or interpretation of Contract terms, or other relief, arising under or relating to this Contract.

Clarifications: Exchanges between the Authority and one (1) or more bidders of a limited nature, whereby bidders may be given the opportunity to clarify certain aspects of their bids or to resolve minor irregularities, informalities or clerical errors.

Constructive Change: An act or omission by the Authority that, although not identified as a Change Order, does in fact cause a change to the Contract.

Contract or Agreement: The written agreement executed between the Authority and the Contractor awarded pursuant to this solicitation.

Contract Administrator: The Authority's representative designated to serve as its primary point of contact for pre-award activities relating to the solicitation as well as such post-award activities as are set forth in the Contract.

Contracting Officer: An employee with authority duly delegated from the powers of the Chief Procurement Officer to legally bind the Authority by signing a Contractual instrument. The Contracting Officer is the Authority's primary point of contact for pre-award administration, modifications above the limits of the Contracting Officer's Representative, and final settlement.

Contracting Officer Representative: The person to whom the Contracting Officer delegates the authority and responsibility for post-award execution of the Contract. The Contracting Officer's Representative is the Authority's primary point of contact with its Contractor.

Contractor: The individual, partnership, firm, corporation, or other business entity that is contractually obligated to the Authority to furnish, through itself or others, the supplies, services and/or construction services described in the Contract, including all incidentals that are necessary to complete the work in accordance with the contract.

Contract Price: The amount payable to the Contractor under the terms and conditions of the Contract based on lump sum prices, unit prices, fixed prices, or combination thereof, with any adjustments made in accordance with the Contract.

Data: Recorded information, regardless of form or the media on which it may be recorded, including technical data and computer software.

Day: Calendar day, except where the term business day, work day or like term is used.

Designer: The individual, partnership, firm, corporation or other business entity that is either the Contractor, or employed or retained by the Contractor, to manage and perform the design services for the Contract.

Disadvantaged Business Enterprise (DBE): A for-profit small business concern that has been certified by the Authority to be at least fifty-one percent (51%) owned by one (1) or more individuals who are both socially and economically disadvantaged or, in the case of a corporation, in which fifty one percent (51%) of the stock is owned by one (1) or more individuals, and whose management and daily business operations are controlled by one (1) or more of the socially and economically disadvantaged individuals who own it.

Descriptive literature: Information provided by an offeror, such as cuts, illustrations, drawings, and brochures that shows a product's characteristics or construction of a product or explains its operation. The term includes only that information needed to evaluate the acceptability of the product and excludes other information for operating or maintaining the product.

Directed, ordered, designated, prescribed or words of like importance: Shall be understood that the direction, requirement, order, designation or prescription of the Contracting Officer is intended and similarly the words approved, acceptable, satisfactory or words of like import shall mean approved by, or acceptable to, or satisfactory to the Contracting Officer, unless otherwise expressly stated.

Explanation: Additional information or clarification provided by an Authority representative to one (1) or more prospective bidders in response to an inquiry relating to the solicitation, that will be binding upon the Authority, only to the extent specified in the Contract.

Equivalent: Of equal or better quality and/or performance to that specified in the Contract as determined by the Authority.

Final Payment: The last payment to the Contractor for work performed under the Contract.

Force Majeure: An unforeseen event or circumstance, beyond the control of, and not occasioned by the fault or neglect of, the Contractor or the Authority, that gives rise to a delay in the progress or completion of the Contract, including, without limitation, acts of God, acts of war or insurrection, unusually severe weather, fires, floods, strikes, freight embargoes or other events or circumstances of like nature.

FTA: Federal Transit Administration, an agency within the United States Department of Transportation that provides financial and technical assistance to local public transit agencies.

Government: The Government of the United States of America.

Industry Standards: Drawings, documents, and specifications or portions thereof published by industry organizations. Industry Standards are not part of this Contract unless specifically listed as such in the Scope of Work.

Legal Requirements: All Federal, state and local laws, ordinances, rules, orders, decrees, and regulatory requirements such as: building codes, mechanical codes, electrical codes, fire codes, Americans with Disabilities Act Accessibility Guidelines (ADAAG), and other regulations of any government or quasi-government entity that are applicable to this Contract.

Milestone: A specified date in the Contract by which the Contractor is required to complete a designated portion or segment of the work.

Minor Irregularity: A variation from the solicitation contained in a bid that does not affect the price or other material term of the Contract and does not confer a competitive advantage or benefit not enjoyed by other offerors or adversely impact the Authority's interests.

Notice to Proceed: Written notice issued by the Authority establishing the date on which the Contractor may commence work and directing the Contractor to proceed with all or a portion of the work.

Offeror: A party submitting a bid in response to this solicitation.

Option: A unilateral right in the Contract by which, for a specified time, the Authority may elect to purchase, at a predetermined price, additional supplies, services and/or work called for by the Contract or to extend the term of the Contract.

Organizational conflict of interest: A circumstance in which, because of other activities or relationships, a person, corporation or other business entity is unable or potentially unable to render impartial assistance or advice to the Authority, or its objectivity in performing the Contract is or might be otherwise impaired, or it has an unfair competitive advantage.

Period of Performance: The time allotted in the Contract for completion of the work. The period of performance begins upon the effective date of Contract execution and ends on the last date for complete performance of the final option. The period of performance incorporates the milestones established for the Contract.

Pre-award Survey: An evaluation of a prospective Contractor's capability to perform a proposed Contract, including an assessment of matters relating to its responsibility.

Product Data: Information furnished by the Contractor to describe materials used for some portion of the work, such as written or printed descriptions, illustrations, standard schedules, performance charts, instructions, brochures, and diagrams.

Records: Books, documents, accounting procedures and practices, and other data, regardless of type and regardless of whether such items are in written form, in the form of computer data, or in any other form.

Safety Sensitive: FTA regulations at 49 C.F.R. § 655.4 define “safety sensitive functions” as any of the following duties when performed by WMATA as a grant recipient, or any of its contractors: (a) Operating a revenue service vehicle, including when it is not in revenue service; (b) Operating a nonrevenue service vehicle, when required to be operated by the holder of a commercial driver’s license (CDL); (c) Controlling dispatch or movement of a revenue service vehicle; (d) Maintaining (including repairs, overhaul and rebuilding) a revenue service vehicle or equipment used in revenue service; and (e) Carrying a firearm for security purposes. WMATA’s definition of safety sensitive functions extends beyond FTA’s requirements and includes (f) Employees and contractors who maintain escalators and elevators (including repairs, overhauls and rebuilding) and (g) Station managers.

Services: The performance of work by a person or legal entity under contract with the Authority, including without limitation: maintenance; overhaul; repair; servicing; rehabilitation; salvage; modernization or modification of supplies, systems or equipment; routing, recurring maintenance of real property; housekeeping; operation of Authority-owned equipment, facilities and systems; communication services; Architect-Engineering services; professional and consulting services; and transportation and related services.

Small Business Enterprise Set-Aside: Competitive procurement(s), less than \$500,000, exclusively for SBE certified bidders/proposers.

Supplies: The end item(s) required to be furnished by the Contractor in fulfillment of its obligation under this Contract as well as any and all related services and required performance.

Statement of Work/Scope of Work (SOW): The portion of a contract or IFB that describes specifically what is to be done by the Contractor. It may include specifications, performance outcomes, dates and time of performance, quality requirements, etc.

Solicitation: This Invitation for Bids (IFB).

Shop Drawings: Fabrication, erection, layout, setting, schematic, and installation drawings that the Contractor prepares for permanent structures, equipment, and systems it designed to comply with this Contract.

Similar: Generally the same but not necessarily identical; details shall be worked out in relation to location and relation to other parts of the work.

Site: The areas that are occupied by or used by the Contractor and subcontractors during performance of the Contract.

Small Business Enterprise (SBE): A for profit small business concern that has been certified by the Authority to be at least fifty one percent (51%) owned by one (1) or more individuals who are economically disadvantaged.

Small Business & Local Preference Program: Board mandated small business contracting program for WMATA funded contracts with firm(s) located in the District of Columbia, Maryland or Virginia.

Subcontract: An agreement between the Contractor and another party, or between other subcontractors at any tier, to perform a portion of the Contract through the acquisition of specified supplies, materials, equipment or services.

Subcontractor: An individual, firm, partnership, or corporation that has a contractual obligation with the Contractor or other subcontractors.

Submittal: Written or graphic document or samples prepared for the work by the Contractor or a subcontractor and submitted to the Authority, including shop drawings, product data, samples, certificates, schedules of material, or other data.

Substantial Completion: Work or a portion thereof that has progressed to the point where it is sufficiently complete in accordance with the Contract (including receipt of test and inspection reports) so that it , can be utilized for the purpose for which it is intended, and only incidental work remains for physical completion in accordance with the Contract.

Substitution: An item offered by the Contractor of significant difference in material, equipment, or configuration, that functionally meets the requirements of the Contract, but is submitted in lieu of item specified therein.

Utility: A public and/or private facility or installation, other than WMATA's facility, that relates to (1) the conveyance and supply of water, sewage, gas, chemicals, steam, petroleum products, and other piped installations, or (2) electrical energy, telephone, radio, television, and cellular or wireless communications.

Utility Standards: Drawings and specifications for utilities published or issued by municipalities or utility companies.

WMATA Safety Manual: A compilation of the appropriate safety and reporting requirements for the project as specified in the Contract.

WMATA Safety and Security Certification Program Plan: A compilation of the appropriate system safety and security certification requirements for the project.

Work: All of the services of any kind, as well as any and all goods, supplies, equipment, labor, and material, of any type and nature to be furnished and/or performed pursuant to this Contract to accomplish the Contract's stated objectives in a timely and fully satisfactory manner.